



High Performance Pneumatic Valves Viking Xtreme Series

G1/8- G1/2 body ported

Catalogue PDE2569TCUK October 2012

aerospace
climate control
electromechanical
filtration
fluid & gas handling
hydraulics
pneumatics
process control
sealing & shielding



ENGINEERING YOUR SUCCESS.

| | |
|---|---------|
| Material Specification..... | 7 |
| Flow Characteristics..... | 8 |
| Order Key - Viking Xtreme Pneumatic + Lever Valves..... | 9 |
| Main Data Pneumatic + Manually Operated Valves..... | 10 - 12 |
| Order Key - Normal Operating Pressure..... | 13 |
| Main Data Electrically Actuated Directional Control Valves Normal | 14 - 19 |
| Order Key - Viking Xtreme Valves..... | 20 |
| Main Data Electrically Actuated Directional Control Valves Xtreme..... | 21 - 23 |
| Dimensions - P2LAX / P2LBX / P2LCX / P2LDX..... | 24 - 44 |
| P2LA, Flexible Manifold Assembly | 45 |
| P2LA, Accessorie Order Codes | 46 - 50 |
| Manifold Dimensions..... | 47 - 50 |
| Solenoid Valves - 15mm..... | 51 |
| Solenoid Valves Order Key - 15mm..... | 52 |
| Solenoid Valves Technical Data - 15mm..... | 53 |
| Solenoid Valves - 22mm..... | 54 |
| Solenoid Valves Order Key - 22mm..... | 55 |
| Solenoid Valves Technical Data - 22mm..... | 56 - 57 |
| Solenoid Connectors + Cable Plugs..... | 58 - 59 |
| Service and Replacement Parts..... | 59 |



Important !
 Before carrying out any service work, ensure that the valve and manifold have been vented. Remove the primary supply air hose to ensure total disconnection of the air supply before dismantling valves or blank connection blocks.



NB !
 All technical data in this catalogue is typical only. The air quality is decisive for the valve life: see ISO 8573.



WARNING

FAILURE OR IMPROPER SELECTION OR IMPROPER USE OF THE PRODUCTS AND/OR SYSTEMS DESCRIBED HEREIN OR RELATED ITEMS CAN CAUSE DEATH, PERSONAL INJURY AND PROPERTY DAMAGE.
 This document and other information from Parker Hannifin Corporation, its subsidiaries and authorized distributors provide product and/or system options for further investigation by users having technical expertise. It is important that you analyze all aspects of your application and review the information concerning the product or system in the current product catalog. Due to the variety of operating conditions and applications for these products or systems, the user, through its own analysis and testing, is solely responsible for making the final selection of the products and systems and assuring that all performance, safety and warning requirements of the application are met. The products described herein, including without limitation, product features, specifications, designs, availability and pricing, are subject to change by Parker Hannifin Corporation and its subsidiaries at any time without notice.

SALE CONDITIONS

The items described in this document are available for sale by Parker Hannifin Corporation, its subsidiaries or its authorized distributors. Any sale contract entered into by Parker will be governed by the provisions stated in Parker's standard terms and conditions of sale (copy available upon request).

Extreme Environments Demand The Viking Xtreme



The Viking Xtreme valve range is robust, versatile and combines high performance with compact installation dimensions. Large flow capacity, short change-over times and low change-over pressure are important characteristics of this valve range.

The 1/8 & 1/4 sizes are designed to operate with pressures up to 16 bar and the 3/8 & 1/2 sizes up to 12 bar, in ambient temperatures -40°C to + 60°C when fitted with suitable solenoid operators.

Viking Xtreme range

- P2LAX, dimension G1/8**
- P2LBX, dimension G1/4**
- P2LCX, dimension G3/8**
- P2LDX, dimension G1/2**

Wide range of 3/2, 5/2 and 5/3 valves for manual, pneumatic or electric operation

Pilot chamber breathers are protected against ingress of dust and dirt.

Robust valve anodised aluminium valve body. The bore is polished to a very high surface finish for maximum flow capacity and long life.

Aluminium spool with nitrile rubber coating, ground to exact size for optimum performance.

Stainless steel end cover screws resist aggressive environments.

Diecast end covers

Over-moulded single piece aluminium spool

- Reduced product complexity
- Increased flow
- Wide operating temperature range.
- Stable seal performance even with high flow/pressure drop across spool.

Precision ground for maximum performance

Nitrile overmoulding

Manually operated range

The complete range includes lever operated versions. They feature a rugged hand lever specifically designed for gloved hands and are available in 3/2, 5/2 and 5/3 functions

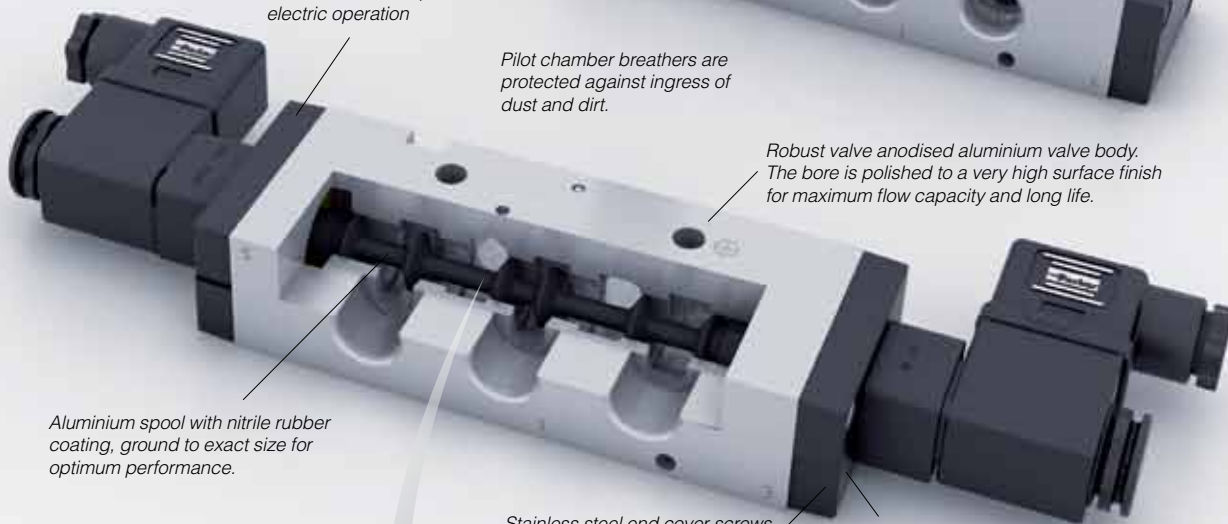

Whatever the environment, Push it to the Xtreme



Compact installation dimensions - flexible installation

Compact dimensions direct body porting and integral mounting holes are all features of the Viking Xtreme range. In addition to single valve installation, the Viking valve may be installed on manifolds so that the valves have a common supply and manifolded exhausts.

Mobile applications

The Viking Xtreme valves have a robust body which is machined out of solid aluminium bar and then anodised. Valves have passed aggressive salt spray, and demanding vibration tests and will operate in ambient temperatures of -40°C to $+60^{\circ}\text{C}$. Solenoids are available having wide voltage tolerance for mobile applications.

Maintenance

The Viking Xtreme valve range has been developed from the very successful VGD15 and P2L-A product ranges which have a history of reliable and long service life in demanding and difficult applications. Spares kits are available for the valve and solenoid operators.

Manually operated versions

The range has now been extended to include lever operated versions. The rugged lever actuator has been specifically designed for gloved hands to suit mobile applications in the most arduous of environments. Available in 3/2, 5/2 and 5/3 functions with either spring return or detented lever and with a choice of mid position function in the 5/3 versions. The lever actuated versions are available across the entire range of port sizes G1/8, G1/4, G3/8 and G1/2.

High reliability

Valves easily comply with the requirements for the component reliability in accordance with EU Machinery Directive standards EN292-2 and EN983. The valves have passed shocks & vibrations test IEC6173: 1999 cat 1 class B

The Viking Xtreme valves have few moving parts combined with short spool movement, these features combine to give valves having high reliability and long service life. The valves are designed for use with or without supplementary lubrication.

Rust and corrosion resistant designs.

Viking valves are made entirely of anodized aluminium, for good corrosion resistance. The smooth design, with no dirt-collecting pockets, makes the valve suitable for most environments, including applications with stringent hygiene requirements. The valve has stainless steel fixing screws for the end covers, to withstand aggressive environments.

Insensitive to dirty air

Thanks to large flow passage areas and the large flow diameter of 1.0 in the pilot valves, the P2LA and P2LB can be used in normal industrial or mobile environments without any problems of blocking. However the service life of the valve depends on the cleanliness of the air. Please refer to ISO 8573. Valves having ATEX approval
ATEX approved options are available for use in explosive atmospheres. Consult our Technical Sales Department for further information.

Complete range

Manual, pneumatic, electric, 3/2, 5/2 & 5/3; the viking Xtreme valve range is suitable for a multiple application. For mobile or industrial applications, all functions are available from G1/8 to G1/2 using the same design and technology



Road



Industrial



Oil & Gas



Flexible multiple installation

There is a system of multiple installation plates, intermediate blocks and several variants of connectors for the P2LA. Several variants of connectors are available, which permit connection from above, beneath, straight from the side or in the middle of a valve block. Using the type L manifold, valve blocks may be constructed for supplying several different pressures.

Manifold bar installation

A manifold bar, with common ducts for ports 1, 3 and 5 gives simple, time saving and easily serviced installation. Manifold bars are available in several different sizes, with space for between 2 and 14 valves. They are designed for simple handling and are entirely serviced from the front.

Pressure bar installation

A pressure bar for common primary air supply gives a simple, robust, time saving and easily serviced installation. When pressure bars are used, restrictor-silencers can be installed in the exhaust ports of each valve, for individual adjustment of cylinder/air motor speed. Pressure bars are available in a number of different sizes, with space ranging from 2 to 10 valves.



Rail



Agri-Food



Forestry

Working medium, air quality

Working medium: Dry, filtered compressed air to ISO 8573-1 class 3.4.3.

Recommended air quality for valves

For best possible service life and trouble free operation, ISO 8573-1 quality class 3.4.3 should be used. This means 5µm filter (standard filter) dew point +3°C for indoor operation (a lower dew point should be selected for outdoor operation) and oil concentration 1.0 mg oil/m³, which is what a standard compressor with a standard filter gives.

ISO 8573-1 quality classes

| Quality class | Pollution | | Water max. press. dew point (°C) | Oil max. concentration (mg/m ³) |
|---------------|--------------------|---|----------------------------------|---|
| | particle size (µm) | max. concentration (mg/m ³) | | |
| 1 | 0,1 | 0,1 | -70 | 0,01 |
| 2 | 1 | 1 | -40 | 0,1 |
| 3 | 5 | 5 | -20 | 1,0 |
| 4 | 15 | 8 | +3 | 5,0 |
| 5 | 40 | 10 | +7 | 25 |
| 6 | - | - | +10 | - |

Typical cylinders speeds which can be achieved with Viking valves and different tube sizes.

In the chart below you can find the suitable valves, tubes etc. for each cylinder size. If you have a tube length over 2 m, choose one tube size larger than in the chart.

Following data is valid:

- Supply pressure : min 7,0 bar
- Regulator pressure setting : 6,0 bar
- Pipe length between air treatment unit and valve : max 1 m
- Pipe length between valve and cylinder : max 2 m

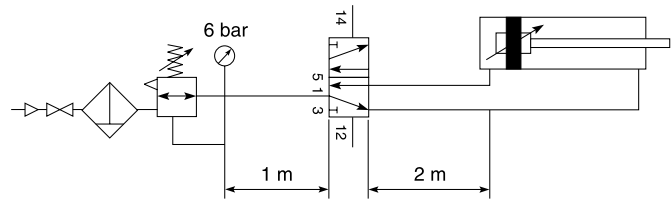

| Cylinder bore | <20 | 20-32 | 40-50 | 63 | 80 | 100 | 125 | 160 | 200 |
|----------------|-------|-------|-------|------|------|-------|-------|-------|-------|
| Cylinder port | M5 | G1/8 | G1/4 | G3/8 | G3/8 | G1/2 | G1/2 | G3/4 | G3/4 |
| Tubing Ext/Int | 4/2.7 | 6/4 | 8/6 | 10/8 | 10/8 | 12/9 | 14/11 | 18/15 | 20/18 |
| | | | 6/4 | 8/6 | 12/9 | 14/11 | | | |
| P2LAX | G1/8 | G1/8 | G1/8 | G1/8 | G1/8 | | | | |
| P2LBX | G1/4 | G1/4 | G1/4 | G1/4 | G1/4 | G1/4 | | | |
| P2LCX | | | G3/8 | G3/8 | G3/8 | G3/8 | G3/8 | | |
| P2LDX | | | | G1/2 | G1/2 | G1/2 | G1/2 | G1/2 | G1/2 |

Cylinder speed < 0,5 m/s
 Cylinder speed < 1 m/s

Oversized
 Cylinder speed > 1 m/s

Material specification

P2LAX

Valve

| | |
|------------------------------|---|
| Valve body | Anodised aluminium |
| End covers | Anodised aluminium |
| Lever housing | Acetal plastic |
| Spool | Aluminium + nitrile rubber |
| Piston | Acetal plastic/ Anodised aluminium |
| End cover sealings | Nitrile rubber |
| End cover screws | Stainless steel |
| Springs | Dacromet® - processed steel, Stainless steel |
| Lever | Reinforced polyamid plastic |
| Panel mounting nut | Polycarbonate plastic |
| Gaiter | Chloroprene rubber |
| Mounting screws for solenoid | Stainless steel |

Accessories

| | |
|-----------------------------|--------------------|
| Manifold bar | Anodised aluminium |
| Pressure bar | Anodised aluminium |
| Multiple manifolds | Anodised aluminium |
| End and intermediate blocks | Anodised aluminium |

P2LCX

Valve

| | |
|------------------------------|---|
| Valve body | Anodised aluminium |
| End covers | Anodised aluminium |
| Spool | Aluminium + nitrile rubber |
| Piston | Acetal plastic/ Anodised aluminium |
| End cover sealings | Nitrile rubber |
| End cover screws | Stainless steel |
| Springs | Dacromet® - processed steel, Stainless steel |
| Lever | Reinforced polyamid plastic |
| Gaiter | Chloroprene rubber |
| Mounting screws for solenoid | Stainless steel |

P2LBX

Valve

| | |
|------------------------------|---|
| Valve body | Anodised aluminium |
| End covers | Anodised aluminium |
| Lever housing | Anodised aluminium |
| Spool | Aluminium + nitrile rubber |
| Piston | Acetal plastic/ Anodised aluminium |
| End cover sealings | Nitrile rubber |
| End cover screws | Stainless steel |
| Springs | Dacromet® - processed steel, Stainless steel |
| Lever | Reinforced polyamid plastic |
| Gaiter | Chloroprene rubber |
| Mounting screws for solenoid | Stainless steel |
| Panel Washer | Nitrile |
| Twist Bush | Acetal |
| Helix Bush | Brass |
| Pin | Plated Steel |
| Twist Housing | Anodised Aluminium |
| Twist Knob | Polyamide 6 |
| Panel mounting ring | Acetal |

Accessories

| | |
|--------------|--------------------|
| Manifold bar | Anodised aluminium |
| Pressure bar | Anodised aluminium |

P2LDX

Valve

| | |
|------------------------------|---|
| Valve body | Anodised aluminium |
| End covers | Anodised aluminium |
| Spool | Aluminium + nitrile rubber |
| Piston | Acetal plastic/ Anodised aluminium |
| End cover sealings | Nitrile rubber |
| End cover screws | Stainless steel |
| Springs | Dacromet® - processed steel, Stainless steel |
| Lever | Reinforced polyamid plastic |
| Gaiter | Chloroprene rubber |
| Mounting screws for solenoid | Stainless steel |

Flow characteristics

Flow capacities in accordance with ISO6358
 All pressures = effective pressure
 The curves in the diagram below are typical only

Technical Data P2LAX

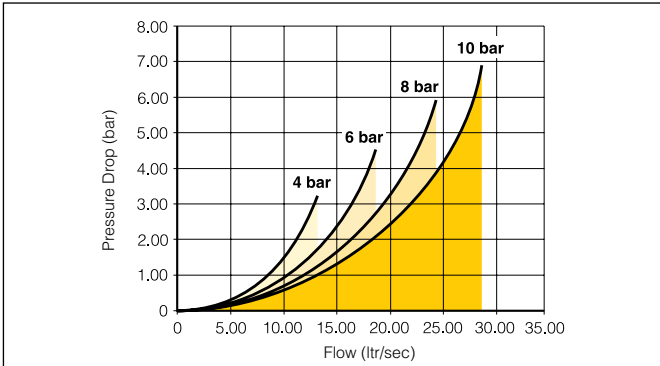

| | |
|----------------------------|---|
| Port size | G1/8 |
| Max operating pressure. | 16 bar |
| Working temperature. | |
| Air pilot lever solenoid. | -40°C to + 60°C |
| Air pilot solenoid. | -10°C to + 50°C |
| Standard and food version. | -40°C to + 60°C |
| Mobile version. | -40°C to + 60°C |
| Flow (acc. to ISO 6358) | $c = 3,0 \text{ NI/s} \times \text{bar}$ $b = 0,2$ $Q_n = 11,0 \text{ l/s}$ $Q_{max} = 19,0 \text{ l/s}$ $C_v = 0,65$ |

Technical Data P2LBX

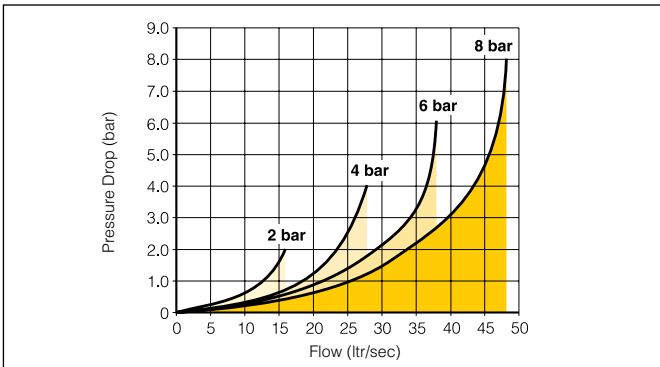

| | |
|----------------------------|---|
| Port size | G1/4 |
| Max operating pressure. | 16 bar |
| Working temperature. | |
| Air pilot lever solenoid. | -40°C to + 60°C |
| Air pilot solenoid. | -10°C to + 50°C |
| Standard and food version. | -40°C to + 60°C |
| Mobile version. | -40°C to + 60°C |
| Flow (acc. to ISO 6358) | $c = 5,4 \text{ NI/s} \times \text{bar}$ $b = 0,2$ $Q_n = 21,5 \text{ l/s}$ $Q_{max} = 38,0 \text{ l/s}$ $C_v = 1,33$ |

Technical Data P2LCX

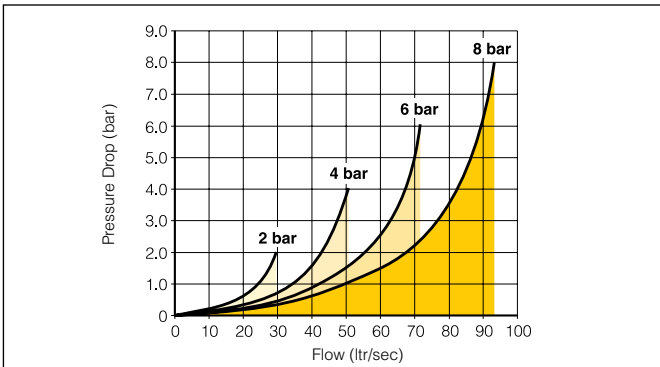

| | |
|----------------------------|--|
| Port size | G3/8 |
| Max operating pressure. | 12 bar |
| Working temperature. | |
| Air pilot lever solenoid. | -40°C to + 60°C |
| Air pilot solenoid. | -10°C to + 50°C |
| Standard and food version. | -40°C to + 60°C |
| Mobile version. | -40°C to + 60°C |
| Flow (acc. to ISO 6358) | $c = 10,3 \text{ NI/s} \times \text{bar}$ $b = 0,22$ $Q_n = 41,0 \text{ l/s}$ $Q_{max} = 72,0 \text{ l/s}$ $C_v = 2,5$ |

Technical Data P2LDX

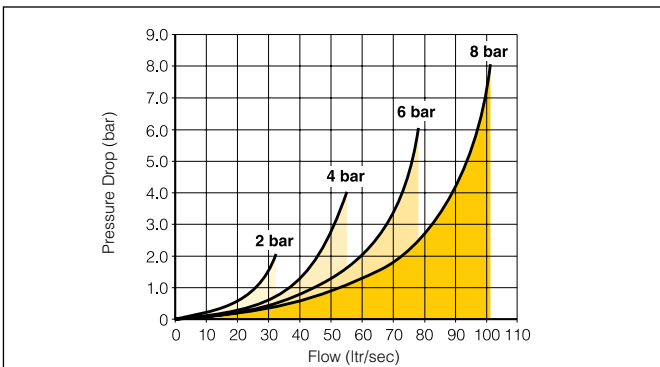

| | |
|----------------------------|--|
| Port size | G1/2 |
| Max operating pressure. | 12 bar |
| Working temperature. | |
| Air pilot lever solenoid. | -40°C to + 60°C |
| Air pilot solenoid. | -10°C to + 50°C |
| Standard and food version. | -40°C to + 60°C |
| Mobile version. | -40°C to + 60°C |
| Flow (acc. to ISO 6358) | $c = 11,3 \text{ NI/s} \times \text{bar}$ $b = 0,3$ $Q_n = 44,3 \text{ l/s}$ $Q_{max} = 78 \text{ l/s}$ $C_v = 2,71$ |

Order chart - Viking Xtreme air pilot & manual valves - Xtreme operating pressure / temperature

| | | |
|----------|----------|----------|
| P | 2 | L |
|----------|----------|----------|

| |
|----------|
| A |
|----------|

| |
|----------|
| X |
|----------|

| |
|----------|
| 5 |
|----------|

| | |
|----------|----------|
| 1 | 1 |
|----------|----------|





| | |
|----------|----------|
| P | S |
|----------|----------|

| Valve family | |
|--------------|---------------------|
| P2L | Viking inline valve |

| Size | |
|----------|-----|
| A | 1/8 |
| B | 1/4 |
| C | 3/8 |
| D | 1/2 |

| Version | |
|----------|-------------------|
| X | Xtreme duty spool |

* Xtreme duty spool suitable for max operating pressure 16 bar. (P2LAX + P2LBX) 12 bar (P2LCX + P2LDX) Temperature range -40°C to +60°C

| Valve type function | | |
|-------------------------------|---|----------------------------------|
| Manual and pneumatic operated | | |
| 3 |  | 3/2 valve |
| 5 |  | 5/2 valve |
| 6 |  | 5/3 valve closed centre position |
| 7 |  | 5/3 valve pressurised centre |
| 8 |  | 5/3 valve vented centre |

Shaded part numbers are standard

| Port thread | |
|-------------|---------------|
| 11 | G1/8 |
| 12 | G1/4 |
| 13 | G3/8 |
| 14 | G1/2 |
| 91 | 1/8 NPT |
| 92 | 1/4 NPT |
| 93 | 3/8 NPT |
| 94 | 1/2 NPT |
| 1N * | Namur G1/4 |
| 9N * | Namur 1/4 NPT |

* Not available in 3/2 version

| Pilot main actuator/return | |
|----------------------------|---|
| J *** | Rotary button - 2 positions |
| P | Air signal |
| S | Spring (return only) |
| V | Lever, 2 positions, 90° to ports |
| 1 ** | Lever, 3 positions self centred, 90° to ports |
| 2 ** | Lever, held 3 positions, 90° to ports |
| 7 *** | Rotary button - 3 positions held in position |

** Not available in 3/2 version
*** Only Available with port threads G1/4 and 1/4 NPT

Pneumatic pilot operated valves - Xtreme operating pressure / temperature





Max operating pressure 16 bar (A & B) 12 bar (C & D). temp range -40°C to +60°C

| Symbol | Size | Actuation | Return | Min Operating Pressure (bar) | Changeover time (ms) at 6 bar @20°C actua./return | Weight Kg | Order code |
|---|------|---------------|------------|------------------------------|---|--------------|-------------------|
| 3/2 valves, temperature -40°C to +60°C | | | | | | | |
| | G1/8 | Air signal | Air signal | 1,5 | 5/5 | 0,30 | P2LAX311PP |
| | G1/4 | | | 1,5 | 5/5 | 0,30 | P2LBX312PP |
| | G3/8 | | | 1,5 | 8/8 | 0,45 | P2LCX313PP |
| | G1/2 | | | 1,5 | 9/9 | 0,45 | P2LDX314PP |
| | G1/8 | Air signal | Spring | 3,2 | 8/15 | 0,30 | P2LAX311PS |
| | G1/4 | | | 3,5 | 10/20 | 0,30 | P2LBX312PS |
| | G3/8 | | | 3,5 | 10/30 | 0,45 | P2LCX313PS |
| | G1/2 | | | 3,5 | 10/30 | 0,45 | P2LDX314PS |
| 5/2 valves, temperature -40°C to +60°C | | | | | | | |
| | G1/8 | Air signal | Air signal | 1,5 | 5/5 | 0,14 | P2LAX511PP |
| | G1/4 | | | 1,5 | 6/6 | 0,30 | P2LBX512PP |
| | G3/8 | | | 1,5 | 8/8 | 0,45 | P2LCX513PP |
| | G1/2 | | | 1,5 | 9/9 | 0,45 | P2LDX514PP |
| | G1/8 | Air signal | Spring | 3,2 | 8/15 | 0,15 | P2LAX511PS |
| | G1/4 | | | 3,5 | 10/20 | 0,32 | P2LBX512PS |
| | G3/8 | | | 3,5 | 10/30 | 0,45 | P2LCX513PS |
| | G1/2 | | | 3,5 | 10/30 | 0,45 | P2LDX514PS |
| 5/3 valves, temperature -40°C to +60°C | | | | | | | |
| | G1/8 | Air signal | Air signal | 3,5 | 10/20 | 0,15 | P2LAX611PP |
| | G1/4 | Closed centre | Self | 3,5 | 12/22 | 0,33 | P2LBX612PP |
| | G3/8 | position | centring | 3,5 | 15/35 | 0,50 | P2LCX613PP |
| | G1/2 | | | 3,5 | 15/35 | 0,50 | P2LDX614PP |
| | G1/8 | Air signal | Air signal | 3,5 | 10/20 | 0,15 | P2LAX811PP |
| | G1/4 | Vented centre | Self | 3,5 | 12/22 | 0,33 | P2LBX812PP |
| | G3/8 | position | centring | 3,5 | 15/35 | 0,50 | P2LCX813PP |
| | G1/2 | | | 3,5 | 15/35 | 0,50 | P2LDX814PP |
| | G1/8 | Air signal | Air signal | 3,5 | 10/20 | 0,15 | P2LAX711PP |
| | G1/4 | Pressurised | Self | 3,5 | 12/22 | 0,33 | P2LBX712PP |
| | G3/8 | centre | centring | 3,5 | 15/35 | 0,50 | P2LCX713PP |
| | G1/2 | position | | 3,5 | 15/35 | 0,50 | P2LDX714PP |



Pneumatic twist operated valves - Xtreme operating pressure / temperature

Max operating pressure 16 bar (A & B) 12 bar (C & D). temp range -40°C to +60°C

| Symbol | Size | Actuation | Return | Changeover Angle | Weight Kg | Order code |
|---|------|-----------|--------|------------------|-----------|-------------------|
| 3/2 valves, temperature -40°C to +60°C | | | | | | |
|  | G1/4 | Twist | Twist | 45 | 0.34 | P2LBX312JJ |
| 5/2 valves, temperature -40°C to +60°C | | | | | | |
|  | G1/4 | Twist | Twist | 45 | 0.37 | P2LBX512JJ |
| 5/3 valves, temperature -40°C to +60°C | | | | | | |
|  | G1/4 | Twist | Twist | 54 | 0.41 | P2LBX71277 |
|  | G1/4 | Twist | Twist | 54 | 0.41 | P2LBX61277 |
|  | G1/4 | Twist | Twist | 54 | 0.41 | P2LBX81277 |

Lever operated directional control valves

Max operating pressure 16 bar (A & B) 12 bar (C & D). temp range -40°C to +60°C

| Symbol | Size | Actuation | Return | Changeover angle | Changeover Force | Type | Weight Kg | Order code |
|---|------|--|--------|------------------|------------------|------|-----------|-------------------|
| 3/2 valves, standard temperature / Low temperature, lever 90° to ports | | | | | | | | |
| | G1/8 | Lever | Lever | 20° | 9 N | Std. | 0,33 | P2LAX311VV |
| | G1/4 | Lever | Lever | 20° | 9 N | Std. | 0,33 | P2LBX312VV |
| | G3/8 | Lever | Lever | 32° | 25 N | Std. | 0,40 | P2LCX313VV |
| | G1/2 | Lever | Lever | 32° | 25 N | Std. | 0,60 | P2LDX314VV |
| | G1/8 | Lever | Spring | 20° | 10N | Std. | 0,33 | P2LAX311VS |
| | G1/4 | Lever | Spring | 20° | 10N | Std. | 0,33 | P2LBX312VS |
| | G3/8 | Lever | Spring | 32° | 15 N | Std. | 0,40 | P2LCX313VS |
| | G1/2 | Lever | Spring | 32° | 15 N | Std. | 0,60 | P2LDX314VS |
| 5/2 valves, standard temperature / Low temperature, lever 90° to ports | | | | | | | | |
| | G1/8 | Lever | Lever | 28° | 9 N | Std. | 0,18 | P2LAX511VV |
| | G1/4 | Lever | Lever | 20° | 9 N | Std. | 0,33 | P2LBX512VV |
| | G3/8 | Lever | Lever | 32° | 25 N | Std. | 0,40 | P2LCX513VV |
| | G1/2 | Lever | Lever | 32° | 25 N | Std. | 0,60 | P2LDX514VV |
| | G1/8 | Lever | Spring | 28° | 10N | Std. | 0,18 | P2LAX511VS |
| | G1/4 | Lever | Spring | 20° | 10N | Std. | 0,33 | P2LBX512VS |
| | G3/8 | Lever | Spring | 32° | 15 N | Std. | 0,40 | P2LCX513VS |
| | G1/2 | Lever | Spring | 32° | 15 N | Std. | 0,60 | P2LDX514VS |
| 5/3 valves, low temperature, lever 90° to ports | | | | | | | | |
| | G1/8 | Lever | Lever | ±14° | 15 N | Std. | 0,18 | P2LAX61122 |
| | G1/4 | Closed centre position held in three positions | | ±12° | 15 N | Std. | 0,33 | P2LBX61222 |
| | G3/8 | | | ±16° | 17 N | Std. | 0,71 | P2LCX61322 |
| | G1/2 | | | ±16° | 17 N | Std. | 0,73 | P2LDX61422 |
| | G1/8 | Lever | Lever | ±14° | 15 N | Std. | 0,18 | P2LAX81122 |
| | G1/4 | Exhausted centre position held in three positions | | ±12° | 15 N | Std. | 0,33 | P2LBX81222 |
| | G3/8 | | | ±16° | 17 N | Std. | 0,71 | P2LCX81322 |
| | G1/2 | | | ±16° | 17 N | Std. | 0,73 | P2LDX81422 |
| | G1/8 | Lever | Lever | ±14° | 15 N | Std. | 0,18 | P2LAX71122 |
| | G1/4 | Pressure applied centre position held in three positions | | ±12° | 15 N | Std. | 0,33 | P2LBX71222 |
| | G3/8 | | | ±16° | 17 N | Std. | 0,71 | P2LCX71322 |
| | G1/2 | | | ±16° | 17 N | Std. | 0,73 | P2LDX71422 |
| | G1/8 | Lever | Lever | ±14° | 16 N | Std. | 0,18 | P2LAX61111 |
| | G1/4 | Closed centre position Self centring | | ±12° | 16 N | Std. | 0,33 | P2LBX61211 |
| | G3/8 | | | ±16° | 30 N | Std. | 0,71 | P2LCX61311 |
| | G1/2 | | | ±16° | 30 N | Std. | 0,73 | P2LDX61411 |
| | G1/8 | Lever | Lever | ±14° | 16 N | Std. | 0,18 | P2LAX81111 |
| | G1/4 | Exhausted centre position Self centring | | ±12° | 16 N | Std. | 0,33 | P2LBX81211 |
| | G3/8 | | | ±16° | 30 N | Std. | 0,71 | P2LCX81311 |
| | G1/2 | | | ±16° | 30 N | Std. | 0,73 | P2LDX81411 |
| | G1/8 | Lever | Lever | ±14° | 16 N | Std. | 0,18 | P2LAX71111 |
| | G1/4 | Pressure applied centre position Self centring | | ±12° | 16 N | Std. | 0,33 | P2LBX71211 |
| | G3/8 | | | ±16° | 30 N | Std. | 0,71 | P2LCX71311 |
| | G1/2 | | | ±16° | 30 N | Std. | 0,73 | P2LDX71411 |

Order chart - Viking Xtreme Normal Operating Pressure / Temperature

| | | | | | | | | | | | | | | | |
|----------|----------|----------|----------|----------|----------|----------|----------|----------|----------|----------|----------|----------|----------|----------|----------|
| P | 2 | L | A | X | 5 | 1 | 1 | E | S | N | D | D | B | 4 | 9 |
|----------|----------|----------|----------|----------|----------|----------|----------|----------|----------|----------|----------|----------|----------|----------|----------|

| | |
|--------------------------------|---------------------------|
| Valve family | Port thread |
| P2L Viking inline valve | 11 G1/8 |
| | 12 G1/4 |
| | 13 G3/8 |
| | 14 G1/2 |
| | 91 1/8 NPT |
| | 92 1/4 NPT |
| | 93 3/8 NPT |
| | 94 1/2 NPT |
| | 1N * Namur G1/4 |
| | 9N * Namur 1/4 NPT |

* Namur version not available in 3/2 function

| | |
|-----------------------------------|-------------------------------|
| Solenoid pilot type | Solenoid exhaust |
| N 10 bar / -10°C to 50°C | D Vented |
| L** 10 bar / -10°C to 50°C | N Captured/tapped M5 |
| | X 15mm solenoid vented |

| | |
|--------------|----------------------------|
| Size | Version |
| A 1/8 | X Xtreme duty spool |
| B 1/4 | |
| C 3/8 | |
| D 1/2 | |

| | |
|--|----------------------------------|
| Valve type function | |
| Solenoid operated with internal supply to solenoid | |
| 3 | 3/2 valve |
| 5 | 5/2 valve |
| 6 | 5/3 valve closed centre position |
| 7 | 5/3 valve pressurised centre |
| 8 | 5/3 valve vented centre |
| Solenoid operated with external pilot supply to solenoids through ports 10 & 12 for 3/2 version and through ports 12 & 14 for 5/2 & 5/3 version | |
| L | 3/2 valve |
| N | 5/2 valve |
| P | 5/3 valve closed centre position |
| Q | 5/3 valve pressurised centre |
| R | 5/3 valve vented centre |

| | |
|---|------------------------------------|
| Overrides | Voltage ² |
| A* None | AC DC |
| B* Flush - non locking | 60Hz 50Hz |
| C Flush - locking | 40 12 12 |
| D¹ Extended non-locking | 42 24 22 |
| E* Extended - locking | 45 12 |
| X Less 15mm solenoid | 47* 12 |
| | 48* 24 |
| | 49 24 |
| | 53 120 110 |
| | 57 240 230 |
| | XX valve less solenoid/coil |

* Only available with enclosure 5
¹ 22mm solenoid option

² Shaded part numbers are available from stock
Unshaded part numbers are available on request but will be subject to minimum order quantities
Otherwise order coil/solenoid and valve separately.





| | |
|-------------------------------------|---|
| Pilot main actuator / Return | Solenoid enclosure / Lead length |
| E Solenoid operated valve | 5 15mm, 3 pin Form C/ISO15217 in line with body |
| S Spring (return only) | B 22mm 3-pin Industrial Form B with coil |
| P Press (return only) | N 22mm solenoid pilot less coil |
| | X Valve less 15mm solenoid |
| | L** Low power 22mm solenoid (only available with 24V DC) |

Shaded part numbers are standard

Solenoid operated directional control valves fitted with 15mm solenoid(s) 24V DC

Solenoid plug/connector to ordered separately.



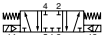
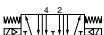
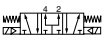



Internal supply to solenoid valve(s) via port 1. Max operating pressure 10 bar, temp range -10°C to +50°C

| Symbol | Size | Actuation | Return | Min Operating Pressure (bar) | Changeover time (ms) at 6 bar @20°C actua./return | Weight Kg | Order code |
|---|------|-----------------|-----------------|------------------------------|---|-----------|-------------------------|
| 3/2 valves, internal air, standard temperature | | | | | | | |
|  | G1/8 | Electric signal | Electric signal | 1,5 | 10/10 | 0,42 | P2LAX311EENXB549 |
| | G1/4 | | | 1,5 | 10/12 | 0,42 | P2LBX312EENXB549 |
| | G3/8 | | | 1,5 | 17/17 | 0,53 | P2LCX313EENXB549 |
| | G1/2 | | | 1,5 | 17/17 | 0,53 | P2LDX314EENXB549 |
|  | G1/8 | Electric signal | Spring | 3,2 | 18/40 | 0,38 | P2LAX311ESNXB549 |
| | G1/4 | | | 3,5 | 18/45 | 0,38 | P2LBX312ESNXB549 |
| | G3/8 | | | 3,5 | 25/75 | 0,50 | P2LCX313ESNXB549 |
| | G1/2 | | | 3,5 | 25/75 | 0,50 | P2LDX314ESNXB549 |
| 5/2 valves, internal air, standard temperature | | | | | | | |
|  | G1/8 | Electric signal | Electric signal | 1,5 | 10/10 | 0,27 | P2LAX511EENXB549 |
| | G1/4 | | | 1,5 | 12/12 | 0,42 | P2LBX512EENXB549 |
| | G3/8 | | | 1,5 | 17/17 | 0,53 | P2LCX513EENXB549 |
| | G1/2 | | | 1,5 | 17/17 | 0,53 | P2LDX514EENXB549 |
|  | G1/8 | Electric signal | Spring | 3,2 | 15/35 | 0,22 | P2LAX511ESNXB549 |
| | G1/4 | | | 3,5 | 18/45 | 0,38 | P2LBX512ESNXB549 |
| | G3/8 | | | 3,5 | 25/75 | 0,50 | P2LCX513ESNXB549 |
| | G1/2 | | | 3,5 | 25/75 | 0,50 | P2LDX514ESNXB549 |
| 5/3 valves, internal air, standard temperature | | | | | | | |
|  | G1/8 | Electric signal | Electric signal | 3,5 | 18/40 | 0,28 | P2LAX611EENXB549 |
| | G1/4 | Closed centre | Self | 3,5 | 22/55 | 0,44 | P2LBX612EENXB549 |
| | G3/8 | position | centring | 3,5 | 30/90 | 0,55 | P2LCX613EENXB549 |
| | G1/2 | | | 3,5 | 30/95 | 0,55 | P2LDX614EENXB549 |
|  | G1/8 | Electric signal | Electric signal | 3,5 | 18/40 | 0,28 | P2LAX811EENXB549 |
| | G1/4 | Vented centre | Self | 3,5 | 22/55 | 0,44 | P2LBX812EENXB549 |
| | G3/8 | position | centring | 3,5 | 30/90 | 0,55 | P2LCX813EENXB549 |
| | G1/2 | | | 3,5 | 30/95 | 0,55 | P2LDX814EENXB549 |
|  | G1/8 | Electric signal | Electric signal | 3,5 | 18/40 | 0,28 | P2LAX711EENXB549 |
| | G1/4 | Pressurised | Self | 3,5 | 22/55 | 0,44 | P2LBX712EENXB549 |
| | G3/8 | centre | centring | 3,5 | 30/90 | 0,55 | P2LCX713EENXB549 |
| | G1/2 | position | | 3,5 | 30/95 | 0,55 | P2LDX714EENXB549 |

Solenoid operated directional control valves fitted with adapter to accept 15mm solenoid(s)

Solenoid operator(s) and connector/plug(s) should be ordered separately.

Internal supply to solenoid valve(s) via port 1. Max operating pressure 10 bar, temp range -10°C to +50°C







| Symbol | Size | Actuation | Return | Min Operating Pressure (bar) | Changeover time (ms) at 6 bar @20°C actua./return | Weight Kg | Order code |
|---|------|-----------------|-----------------|------------------------------|---|-----------|-----------------------|
| 3/2 valves, internal air, standard temperature | | | | | | | |
|  | G1/8 | Electric signal | Electric signal | 1,5 | 10/10 | 0,38 | P2LAX311EENXXX |
| | G1/4 | | | 1,5 | 10/12 | 0,38 | P2LBX312EENXXX |
| | G3/8 | | | 1,5 | 17/17 | 0,45 | P2LCX313EENXXX |
| | G1/2 | | | 1,5 | 17/17 | 0,45 | P2LDX314EENXXX |
|  | G1/8 | Electric signal | Spring | 3,2 | 18/40 | 0,38 | P2LAX311ESNXXX |
| | G1/4 | | | 3,5 | 18/45 | 0,38 | P2LBX312ESNXXX |
| | G3/8 | | | 3,5 | 25/75 | 0,42 | P2LCX313ESNXXX |
| | G1/2 | | | 3,5 | 25/75 | 0,42 | P2LDX314ESNXXX |
| 5/2 valves, internal air, standard temperature | | | | | | | |
|  | G1/8 | Electric signal | Electric signal | 1,5 | 10/10 | 0,27 | P2LAX511EENXXX |
| | G1/4 | | | 1,5 | 12/12 | 0,42 | P2LBX512EENXXX |
| | G3/8 | | | 1,5 | 17/17 | 0,45 | P2LCX513EENXXX |
| | G1/2 | | | 1,5 | 17/17 | 0,45 | P2LDX514EENXXX |
|  | G1/8 | Electric signal | Spring | 3,2 | 15/35 | 0,22 | P2LAX511ESNXXX |
| | G1/4 | | | 3,5 | 18/45 | 0,38 | P2LBX512ESNXXX |
| | G3/8 | | | 3,5 | 25/75 | 0,42 | P2LCX513ESNXXX |
| | G1/2 | | | 3,5 | 25/75 | 0,42 | P2LDX514ESNXXX |
| 5/3 valves, internal air, standard temperature | | | | | | | |
|  | G1/8 | Electric signal | Electric signal | 3,5 | 18/40 | 0,28 | P2LAX611EENXXX |
| | G1/4 | Closed centre | Self | 3,5 | 22/55 | 0,44 | P2LBX612EENXXX |
| | G3/8 | position | centring | 3,5 | 30/90 | 0,55 | P2LCX613EENXXX |
| | G1/2 | | | 3,5 | 30/95 | 0,55 | P2LDX614EENXXX |
|  | G1/8 | Electric signal | Electric signal | 3,5 | 18/40 | 0,28 | P2LAX811EENXXX |
| | G1/4 | Vented centre | Self | 3,5 | 22/55 | 0,44 | P2LBX812EENXXX |
| | G3/8 | position | centring | 3,5 | 30/90 | 0,55 | P2LCX813EENXXX |
| | G1/2 | | | 3,5 | 30/95 | 0,55 | P2LDX814EENXXX |
|  | G1/8 | Electric signal | Electric signal | 3,5 | 18/40 | 0,28 | P2LAX711EENXXX |
| | G1/4 | Pressurised | Self | 3,5 | 22/55 | 0,44 | P2LBX712EENXXX |
| | G3/8 | centre | centring | 3,5 | 30/90 | 0,55 | P2LCX713EENXXX |
| | G1/2 | position | | 3,5 | 30/95 | 0,55 | P2LDX714EENXXX |

Solenoid operated directional control valves fitted with adapter to accept 15mm solenoid(s)

Solenoid operator(s) and connector/plug(s) should be ordered separately.

External supply to solenoid valve(s) via ports 10 & 12 for 3/2 version and via port 12 & 14 for 5/2 and 5/3 version.







Max operating pressure 10 bar, temp range -10°C to +50°C

| Symbol | Size | Actuation | Return | Min Operating Pressure (bar) | Changeover time (ms) at 6 bar @20°C actua./return | Weight Kg | Order code |
|---|------|-----------------|-----------------|------------------------------|---|-----------|-----------------------|
| 3/2 valves, external air, standard temperature | | | | | | | |
|  | G1/8 | Electric signal | Electric signal | 1,5 | 10/10 | 0,34 | P2LAXL11EENXXX |
| | G1/4 | | | 1,5 | 10/12 | 0,34 | P2LBXL12EENXXX |
| | G3/8 | | | 1,5 | 17/17 | 0,45 | P2LCXL13EENXXX |
| | G1/2 | | | 1,5 | 17/17 | 0,45 | P2LDXL14EENXXX |
|  | G1/8 | Electric signal | Spring | 3,2 | 18/40 | 0,34 | P2LAXL11ESNXXX |
| | G1/4 | | | 3,5 | 18/45 | 0,34 | P2LBXL12ESNXXX |
| | G3/8 | | | 3,5 | 25/75 | 0,42 | P2LCXL13ESNXXX |
| | G1/2 | | | 3,5 | 25/75 | 0,42 | P2LDXL14ESNXXX |
| 5/2 valves, external air, standard temperature | | | | | | | |
|  | G1/8 | Electric signal | Electric signal | 1,5 | 10/10 | 0,19 | P2LAXN11EENXXX |
| | G1/4 | | | 1,5 | 12/12 | 0,34 | P2LBXN12EENXXX |
| | G3/8 | | | 1,5 | 17/17 | 0,45 | P2LCXN13EENXXX |
| | G1/2 | | | 1,5 | 17/17 | 0,45 | P2LDXN14EENXXX |
|  | G1/8 | Electric signal | Spring | 3,2 | 15/35 | 0,18 | P2LAXN11ESNXXX |
| | G1/4 | | | 3,5 | 18/45 | 0,34 | P2LBXN12ESNXXX |
| | G3/8 | | | 3,5 | 25/75 | 0,42 | P2LCXN13ESNXXX |
| | G1/2 | | | 3,5 | 25/75 | 0,42 | P2LDXN14ESNXXX |
| 5/3 valves, external air, standard temperature | | | | | | | |
|  | G1/8 | Electric signal | Electric signal | 3,5 | 18/40 | 0,20 | P2LAXP11EENXXX |
| | G1/4 | Closed centre | Self | 3,5 | 22/55 | 0,36 | P2LBXP12EENXXX |
| | G3/8 | position | centring | 3,5 | 30/90 | 0,55 | P2LCXP13EENXXX |
| | G1/2 | | | 3,5 | 30/95 | 0,55 | P2LDXP14EENXXX |
|  | G1/8 | Electric signal | Electric signal | 3,5 | 18/40 | 0,20 | P2LAXR11EENXXX |
| | G1/4 | Vented centre | Self | 3,5 | 22/55 | 0,36 | P2LBXR12EENXXX |
| | G3/8 | position | centring | 3,5 | 30/90 | 0,55 | P2LCXR13EENXXX |
| | G1/2 | | | 3,5 | 30/95 | 0,55 | P2LDXR14EENXXX |
|  | G1/8 | Electric signal | Electric signal | 3,5 | 18/40 | 0,20 | P2LAXQ11EENXXX |
| | G1/4 | Pressurised | Self | 3,5 | 22/55 | 0,36 | P2LBXQ12EENXXX |
| | G3/8 | centre | centring | 3,5 | 30/90 | 0,55 | P2LCXQ13EENXXX |
| | G1/2 | position | | 3,5 | 30/95 | 0,55 | P2LDXQ14EENXXX |

Solenoid operated directional control valves fitted with 22mm solenoid(s) 24V DC

Solenoid plug/connector to be ordered separately.

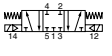
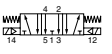





Internal supply to solenoid valve(s) via port 1. Max operating pressure 10 bar, Temperature range -10°C to +50°C

| Symbol | Size | Actuation | Return | Min Operating Pressure (bar) | Changeover time (ms) at 6 bar @20°C actua./return | Weight Kg | Order code |
|---|------|-----------------|-----------------|------------------------------|---|-----------|--------------------------|
| 3/2 valves, internal air, standard temperature | | | | | | | |
|  | G1/8 | Electric signal | Electric signal | 1,5 | 10/10 | 0,42 | P2LAX311EENDDDB49 |
| | G1/4 | | | 1,5 | 10/12 | 0,42 | P2LBX312EENDDDB49 |
| | G3/8 | | | 1,5 | 17/17 | 0,81 | P2LCX313EENDDDB49 |
| | G1/2 | | | 1,5 | 17/17 | 0,81 | P2LDX314EENDDDB49 |
|  | G1/8 | Electric signal | Spring | 3,2 | 18/40 | 0,38 | P2LAX311ESNDDDB49 |
| | G1/4 | | | 3,5 | 18/45 | 0,38 | P2LBX312ESNDDDB49 |
| | G3/8 | | | 3,5 | 25/75 | 0,76 | P2LCX313ESNDDDB49 |
| | G1/2 | | | 3,5 | 25/75 | 0,76 | P2LDX314ESNDDDB49 |
| 5/2 valves, internal air, standard temperature | | | | | | | |
|  | G1/8 | Electric signal | Electric signal | 1,5 | 10/10 | 0,27 | P2LAX511EENDDDB49 |
| | G1/4 | | | 1,5 | 12/12 | 0,42 | P2LBX512EENDDDB49 |
| | G3/8 | | | 1,5 | 17/17 | 0,81 | P2LCX513EENDDDB49 |
| | G1/2 | | | 1,5 | 17/17 | 0,81 | P2LDX514EENDDDB49 |
|  | G1/8 | Electric signal | Spring | 3,2 | 15/35 | 0,22 | P2LAX511ESNDDDB49 |
| | G1/4 | | | 3,5 | 18/45 | 0,38 | P2LBX512ESNDDDB49 |
| | G3/8 | | | 3,5 | 27/75 | 0,76 | P2LCX513ESNDDDB49 |
| | G1/2 | | | 3,5 | 25/75 | 0,76 | P2LDX514ESNDDDB49 |
| 5/3 valves, internal air, standard temperature | | | | | | | |
|  | G1/8 | Electric signal | Electric signal | 3,5 | 18/40 | 0,28 | P2LAX611EENDDDB49 |
| | G1/4 | Closed centre | Self | 3,5 | 22/55 | 0,44 | P2LBX612EENDDDB49 |
| | G3/8 | position | centring | 3,5 | 30/90 | 1,11 | P2LCX613EENDDDB49 |
| | G1/2 | | | 3,5 | 30/90 | 1,11 | P2LDX614EENDDDB49 |
|  | G1/8 | Electric signal | Electric signal | 3,5 | 18/40 | 0,28 | P2LAX811EENDDDB49 |
| | G1/4 | Vented centre | Self | 3,5 | 22/45 | 0,44 | P2LBX812EENDDDB49 |
| | G3/8 | position | centring | 3,5 | 30/90 | 1,11 | P2LCX813EENDDDB49 |
| | G1/2 | | | 3,5 | 30/90 | 1,11 | P2LDX814EENDDDB49 |
|  | G1/8 | Electric signal | Electric signal | 3,5 | 18/40 | 0,28 | P2LAX711EENDDDB49 |
| | G1/4 | Pressurised | Self | 3,5 | 22/45 | 0,44 | P2LBX712EENDDDB49 |
| | G3/8 | centre | centring | 3,5 | 30/90 | 1,11 | P2LCX713EENDDDB49 |
| | G1/2 | position | | 3,5 | 30/90 | 1,11 | P2LDX714EENDDDB49 |

Solenoid operated directional control valves (supplied with 22mm solenoid operator less coil)

Solenoid plug/connector to be ordered separately.

Internal supply to solenoid valve(s) via port 1.

| Symbol | Size | Actuation | Return | Min Operating Pressure (bar) | Changeover time (ms) at 6 bar @20°C actua./return | Weight Kg | Order code |
|---|------|-----------------|-----------------|------------------------------|---|-----------|-----------------------|
| 3/2 valves, internal air, standard temperature | | | | | | | |
|  | G1/8 | Electric signal | Electric signal | 1,5 | 10/10 | 0,31 | P2LAX311EENDDN |
| | G1/4 | | | 1,5 | 10/12 | 0,31 | P2LBX312EENDDN |
| | G3/8 | | | 1,5 | 17/17 | 0,41 | P2LCX313EENDDN |
| | G1/2 | | | 1,5 | 17/17 | 0,41 | P2LDX314EENDDN |
|  | G1/8 | Electric signal | Spring | 3,2 | 18/40 | 0,31 | P2LAX311ESNDDN |
| | G1/4 | | | 3,5 | 18/45 | 0,31 | P2LBX312ESNDDN |
| | G3/8 | | | 3,5 | 25/75 | 0,40 | P2LCX313ESNDDN |
| | G1/2 | | | 3,5 | 25/75 | 0,40 | P2LDX314ESNDDN |
| 5/2 valves, internal air, standard temperature | | | | | | | |
|  | G1/8 | Electric signal | Electric signal | 1,5 | 9/9 | 0,16 | P2LAX511EENDDN |
| | G1/4 | | | 1,5 | 10/10 | 0,31 | P2LBX512EENDDN |
| | G3/8 | | | 1,5 | 13/13 | 0,41 | P2LCX513EENDDN |
| | G1/2 | | | 1,5 | 13/13 | 0,41 | P2LDX514EENDDN |
|  | G1/8 | Electric signal | Spring | 3,2 | 12/38 | 0,16 | P2LAX511ESNDDN |
| | G1/4 | | | 3,5 | 14/42 | 0,31 | P2LBX512ESNDDN |
| | G3/8 | | | 3,5 | 16/60 | 0,40 | P2LCX513ESNDDN |
| | G1/2 | | | 3,5 | 16/60 | 0,40 | P2LDX514ESNDDN |
| 5/3 valves, internal air, standard temperature | | | | | | | |
|  | G1/8 | Electric signal | Electric signal | 3,5 | 15/40 | 0,17 | P2LAX611EENDDN |
| | G1/4 | Closed centre | Self | 3,5 | 18/50 | 0,33 | P2LBX612EENDDN |
| | G3/8 | position | centring | 3,5 | 20/65 | 1,00 | P2LCX613EENDDN |
| | G1/2 | | | 3,5 | 20/70 | 1,00 | P2LDX614EENDDN |
|  | G1/8 | Electric signal | Electric signal | 3,5 | 15/40 | 0,17 | P2LAX811EENDDN |
| | G1/4 | Vented centre | Self | 3,5 | 18/50 | 0,33 | P2LBX812EENDDN |
| | G3/8 | position | centring | 3,5 | 20/65 | 1,00 | P2LCX813EENDDN |
| | G1/2 | | | 3,5 | 20/70 | 1,00 | P2LDX814EENDDN |
|  | G1/8 | Electric signal | Electric signal | 3,5 | 15/40 | 0,17 | P2LAX711EENDDN |
| | G1/4 | Pressurised | Self | 3,5 | 18/50 | 0,33 | P2LBX712EENDDN |
| | G3/8 | centre | centring | 3,5 | 20/65 | 1,00 | P2LCX713EENDDN |
| | G1/2 | position | | 3,5 | 20/70 | 1,00 | P2LDX714EENDDN |

Solenoid operated directional control valves (supplied with 22mm solenoid less coil)

Solenoid plug/connector to be ordered separately.

External supply to solenoid valve(s) via ports 10 & 12 for 3/2 version and via port 12 & 14 for 5/2 and 5/3 version

Standard temp range -10°C to +50°C. Max operating pressure 10 bar

| Symbol | Size | Actuation | Return | Min Operating Pressure (bar) | Changeover time (ms) at 6 bar @20°C actua./return | Weight Kg | Order code |
|---|------|-----------------|-----------------|------------------------------|---|-----------|-----------------------|
| 3/2 valves, external air, standard temperature | | | | | | | |
| | G1/8 | Electric signal | Electric signal | 1,5 | 10/10 | 0,31 | P2LAXL11EENDDN |
| | G1/4 | | | 1,5 | 10/12 | 0,31 | P2LBXL12EENDDN |
| | G3/8 | | | 1,5 | 17/17 | 0,70 | P2LCXL13EENDDN |
| | G1/2 | | | 1,5 | 17/17 | 0,70 | P2LDXL14EENDDN |
| | G1/8 | Electric signal | Spring | 3,2 | 18/40 | 0,30 | P2LAXL11ESNDDN |
| | G1/4 | | | 3,5 | 18/45 | 0,30 | P2LBXL12ESNDDN |
| | G3/8 | | | 3,5 | 25/75 | 0,70 | P2LCXL13ESNDDN |
| | G1/2 | | | 3,5 | 25/75 | 0,70 | P2LDXL14ESNDDN |
| 5/2 valves, external air, standard temperature | | | | | | | |
| | G1/8 | Electric signal | Electric signal | 1,5 | 9/9 | 0,16 | P2LAXN11EENDDN |
| | G1/4 | | | 1,5 | 10/10 | 0,31 | P2LBXN12EENDDN |
| | G3/8 | | | 1,5 | 13/13 | 0,70 | P2LCXN13EENDDN |
| | G1/2 | | | 1,5 | 13/13 | 0,70 | P2LDXN14EENDDN |
| | G1/8 | Electric signal | Spring | 3,2 | 12/38 | 0,16 | P2LAXN11ESNDDN |
| | G1/4 | | | 3,5 | 14/42 | 0,30 | P2LBXN12ESNDDN |
| | G3/8 | | | 3,5 | 16/60 | 0,70 | P2LCXN13ESNDDN |
| | G1/2 | | | 3,5 | 16/60 | 0,70 | P2LDXN14ESNDDN |
| 5/3 valves, external air, standard temperature | | | | | | | |
| | G1/8 | Electric signal | Electric signal | 3,5 | 15/40 | 0,17 | P2LAXP11EENDDN |
| | G1/4 | Closed centre | Self | 3,5 | 18/50 | 0,33 | P2LBXP12EENDDN |
| | G3/8 | position | centring | 3,5 | 20/65 | 1,00 | P2LCXP13EENDDN |
| | G1/2 | | | 3,5 | 20/70 | 1,00 | P2LDXP14EENDDN |
| | G1/8 | Electric signal | Electric signal | 3,5 | 15/40 | 0,17 | P2LAXR11EENDDN |
| | G1/4 | Vented centre | Self | 3,5 | 18/50 | 0,33 | P2LBXR12EENDDN |
| | G3/8 | position | centring | 3,5 | 20/65 | 1,00 | P2LCXR13EENDDN |
| | G1/2 | | | 3,5 | 20/70 | 1,00 | P2LDXR14EENDDN |
| | G1/8 | Electric signal | Electric signal | 3,5 | 15/40 | 0,17 | P2LAXQ11EENDDN |
| | G1/4 | Pressurised | Self | 3,5 | 18/50 | 0,33 | P2LBXQ12EENDDN |
| | G3/8 | centre | centring | 3,5 | 20/65 | 1,00 | P2LCXQ13EENDDN |
| | G1/2 | position | | 3,5 | 20/70 | 1,00 | P2LDXQ14EENDDN |

Order chart - Viking Xtreme Valves - Xtreme operating pressure / temperature

| | | | | | | | | | | | | | | | |
|----------|----------|----------|----------|----------|----------|----------|----------|----------|----------|----------|----------|----------|----------|----------|----------|
| P | 2 | L | A | X | 5 | 1 | 1 | E | S | H | D | D | B | 4 | 9 |
|----------|----------|----------|----------|----------|----------|----------|----------|----------|----------|----------|----------|----------|----------|----------|----------|

| Valve family | |
|--------------|---------------------|
| P2L | Viking inline valve |

| Size | |
|----------|-----|
| A | 1/8 |
| B | 1/4 |
| C | 3/8 |
| D | 1/2 |

| Version | |
|----------|-------------------|
| X | Xtreme duty spool |

| Port thread | |
|-------------|---------|
| 11 | G1/8 |
| 12 | G1/4 |
| 13 | G3/8 |
| 14 | G1/2 |
| 91 | 1/8 NPT |
| 92 | 1/4 NPT |
| 93 | 3/8 NPT |
| 94 | 1/2 NPT |

| Solenoid pilot type | |
|----------------------|------------------------|
| H¹ | 16 bar / -40°C to 60°C |

¹ Solenoid operated 'H' version supplied with B type enclosure 16 bar solenoid











| Solenoid exhaust | |
|------------------|-------------------|
| D | Vented |
| N | Capture/tapped M5 |

| Overrides | |
|-----------|----------------------|
| D | Extended non-locking |

| Voltage ³ | | | |
|----------------------|--------------------------|------|----|
| | AC | | DC |
| | 60Hz | 50Hz | |
| 40 | 12 | | |
| 42 | 24 | 22 | |
| 45 | | | 12 |
| 47* | | | 12 |
| 48* | | | 24 |
| 49 | | | 24 |
| 53 | 120 | 110 | |
| 57 | 240 | 230 | |
| XX | valve less solenoid/coil | | |

* Mobile voltage see page 51 operating parameters

³ Shaded part numbers are available from stock
 Unshaded part numbers are available on request but will be subject to minimum order quantities
 Otherwise order coil and valve separately.

| Valve type function | | |
|---|---|----------------------------------|
| Solenoid operated with internal supply to solenoid | | |
| 3 |  | 3/2 valve |
| 5 |  | 5/2 valve |
| 6 |  | 5/3 valve closed centre position |
| 7 |  | 5/3 valve pressurised centre |
| 8 |  | 5/3 valve vented centre |
| Solenoid operated with external pilot supply to solenoids through ports 10 & 12 for 3/2 version and through ports 12 & 14 for 5/2 & 5/3 version | | |
| L |  | 3/2 valve |
| N |  | 5/2 valve |
| P |  | 5/3 valve closed centre position |
| Q |  | 5/3 valve pressurised centre |
| R |  | 5/3 valve vented centre |

| Pilot main actuator / Return | |
|------------------------------|-------------------------|
| E | Solenoid operated valve |
| S | Spring (return only) |
| P | Press (return only) |

| Solenoid enclosure / Lead length | |
|----------------------------------|---|
| A | 22mm Solenoid pilot & 30mm coil Form A |
| B | 22mm Solenoid pilot & 22mm coil Industrial Form B |
| N | 22mm Solenoid pilot less coil |







Shaded part numbers are standard

Solenoid operated directional control valves - Xtreme duty -40°C to +60°C

P2LAX/P2LBX - 16 bar, P2LCX/P2LDX - 12 bar

Complete with 22mm solenoid and 24V DC coil.

Internal supply to solenoid valve(s) via port 1. Connector/cable plugs to be ordered separately.







| Symbol | Size | Actuation | Return | Min Operating Pressure (bar) | Changeover time (ms) at 6 bar @20°C actua./return | Weight Kg | Order code |
|---|------|-----------------|-----------------|------------------------------|---|-----------|------------------------|
| 3/2 valves, internal air, low temperature | | | | | | | |
|  | G1/8 | Electric signal | Electric signal | 1,5 | 11/11 | 0,42 | P2LAX311EEHDB49 |
| | G1/4 | | Low temp. | 1,5 | 13/13 | 0,42 | P2LBX312EEHDB49 |
| | G3/8 | | | 1,5 | 18/18 | 0,48 | P2LCX313EEHDB49 |
| | G1/2 | | | 1,5 | 18/18 | 0,48 | P2LDX314EEHDB49 |
|  | G1/8 | Electric signal | Spring | 3,2 | 15/45 | 0,38 | P2LAX311ESHDB49 |
| | G1/4 | | Low temp. | 3,5 | 25/65 | 0,38 | P2LBX312ESHDB49 |
| | G3/8 | | | 3,5 | 25/85 | 0,46 | P2LCX313ESHDB49 |
| | G1/2 | | | 3,5 | 25/85 | 0,46 | P2LDX314ESHDB49 |
| 5/2 valves, internal air, low temperature | | | | | | | |
|  | G1/8 | Electric signal | Electric signal | 1,5 | 11/11 | 0,27 | P2LAX511EEHDB49 |
| | G1/4 | | Low temp. | 1,5 | 13/13 | 0,42 | P2LBX512EEHDB49 |
| | G3/8 | | | 1,5 | 18/18 | 0,48 | P2LCX513EEHDB49 |
| | G1/2 | | | 1,5 | 18/18 | 0,48 | P2LDX514EEHDB49 |
|  | G1/8 | Electric signal | Spring | 3,2 | 15/45 | 0,22 | P2LAX511ESHDB49 |
| | G1/4 | | Low temp. | 3,2 | 20/55 | 0,38 | P2LBX512ESHDB49 |
| | G3/8 | | | 3,2 | 25/85 | 0,46 | P2LCX513ESHDB49 |
| | G1/2 | | | 3,2 | 25/85 | 0,46 | P2LDX514ESHDB49 |
| 5/3 valves, internal air, low temperature | | | | | | | |
|  | G1/8 | Electric signal | Electric signal | 3,5 | 18/50 | 0,28 | P2LAX611EEHDB49 |
| | G1/4 | Closed centre | Self | 3,5 | 25/65 | 0,45 | P2LBX612EEHDB49 |
| | G3/8 | position | centring | 3,5 | 30/90 | 0,55 | P2LCX613EEHDB49 |
| | G1/2 | | Low temp. | 3,5 | 30/95 | 0,55 | P2LDX614EEHDB49 |
|  | G1/8 | Electric signal | Electric signal | 3,5 | 18/50 | 0,28 | P2LAX811EEHDB49 |
| | G1/4 | Vented centre | Self | 3,5 | 25/65 | 0,45 | P2LBX812EEHDB49 |
| | G3/8 | position | centring | 3,5 | 30/90 | 0,55 | P2LCX813EEHDB49 |
| | G1/2 | | Low temp. | 3,5 | 30/95 | 0,55 | P2LDX814EEHDB49 |
|  | G1/8 | Electric signal | Electric signal | 3,5 | 18/50 | 0,28 | P2LAX711EEHDB49 |
| | G1/4 | Pressurised | Self | 3,5 | 25/65 | 0,45 | P2LBX712EEHDB49 |
| | G3/8 | centre | centring | 3,5 | 30/90 | 0,55 | P2LCX713EEHDB49 |
| | G1/2 | position | Low temp. | 3,5 | 30/95 | 0,55 | P2LDX714EEHDB49 |

Solenoid operated directional control valves - Xtreme duty -40°C to +60°C

P2LAX/P2LBX - 16 bar, P2LCX/P2LDX - 12 bar

Valves fitted with 22mm solenoid operator(s) less coil(s). Order coils and plug/connectors separately







Internal supply to solenoid valve(s) via port 1. Connector/cable plugs to be ordered separately.

| Symbol | Size | Actuation | Return | Min Operating Pressure (bar) | Changeover time (ms) at 6 bar @20°C actua./return | Weight Kg | Order code |
|---|------|-----------------------------|-----------------|------------------------------|---|-----------|-----------------------|
| 3/2 valves, internal air, low temperature | | | | | | | |
|  | G1/8 | Electric signal | Electric signal | 1,5 | 11/11 | 0,31 | P2LAX311EEHDDN |
| | G1/4 | | | 1,5 | 13/13 | 0,31 | P2LBX312EEHDDN |
| | G3/8 | | | 1,5 | 18/18 | 0,41 | P2LCX313EEHDDN |
| | G1/2 | | | 1,5 | 18/18 | 0,41 | P2LDX314EEHDDN |
|  | G1/8 | Electric signal | Spring | 3,2 | 15/45 | 0,31 | P2LAX311ESHDDN |
| | G1/4 | | | 3,5 | 25/65 | 0,31 | P2LBX312ESHDDN |
| | G3/8 | | | 3,5 | 25/85 | 0,40 | P2LCX313ESHDDN |
| | G1/2 | | | 3,5 | 25/85 | 0,40 | P2LDX314ESHDDN |
| 5/2 valves, internal air, low temperature | | | | | | | |
|  | G1/8 | Electric signal | Electric signal | 1,5 | 11/11 | 0,16 | P2LAX511EEHDDN |
| | G1/4 | | | 1,5 | 13/13 | 0,31 | P2LBX512EEHDDN |
| | G3/8 | | | 1,5 | 18/18 | 0,41 | P2LCX513EEHDDN |
| | G1/2 | | | 1,5 | 18/18 | 0,41 | P2LDX514EEHDDN |
|  | G1/8 | Electric signal | Spring | 3,2 | 15/45 | 0,16 | P2LAX511ESHDDN |
| | G1/4 | | | 3,2 | 20/55 | 0,31 | P2LBX512ESHDDN |
| | G3/8 | | | 3,2 | 25/85 | 0,40 | P2LCX513ESHDDN |
| | G1/2 | | | 3,2 | 25/85 | 0,40 | P2LDX514ESHDDN |
| 5/3 valves, internal air, low temperature | | | | | | | |
|  | G1/8 | Electric signal | Electric signal | 3,5 | 18/50 | 0,17 | P2LAX611EEHDDN |
| | G1/4 | Closed centre position | Self centring | 3,5 | 25/65 | 0,33 | P2LBX612EEHDDN |
| | G3/8 | | | 3,5 | 30/90 | 0,42 | P2LCX613EEHDDN |
| | G1/2 | | | 3,5 | 30/95 | 0,42 | P2LDX614EEHDDN |
|  | G1/8 | Electric signal | Electric signal | 3,5 | 18/50 | 0,17 | P2LAX811EEHDDN |
| | G1/4 | Vented centre position | Self centring | 3,5 | 25/65 | 0,33 | P2LBX812EEHDDN |
| | G3/8 | | | 3,5 | 30/90 | 0,42 | P2LCX813EEHDDN |
| | G1/2 | | | 3,5 | 30/95 | 0,42 | P2LDX814EEHDDN |
|  | G1/8 | Electric signal | Electric signal | 3,5 | 18/50 | 0,17 | P2LAX711EEHDDN |
| | G1/4 | Pressurised centre position | Self centring | 3,5 | 25/65 | 0,33 | P2LBX712EEHDDN |
| | G3/8 | | | 3,5 | 30/90 | 0,42 | P2LCX713EEHDDN |
| | G1/2 | | | 3,5 | 30/95 | 0,42 | P2LDX714EEHDDN |

Solenoid operated directional control valves - Xtreme duty -40°C to + 60°C

P2LAX/P2LBX - 16 bar, P2LCX/P2LDX - 12 bar

Valves fitted with 22mm solenoid operator(s) less coil(s). Order coils and plug/connectors separately
 External supply to solenoid valve(s) via ports 10 & 12 for 3/2 version and via port 12 & 14 for 5/2 and 5/3 version

| Symbol | Size | Actuation | Return | Min Operating Pressure (bar) | Changeover time (ms) at 6 bar @20°C actua./return | Weight Kg | Order code |
|---|------|-----------------|-----------------|------------------------------|---|-----------|-----------------------|
| 3/2 valves, external air standard temperature | | | | | | | |
|  | G1/8 | Electric signal | Electric signal | 1,5 | 10/10 | 0,42 | P2LAXL11EEHDDN |
| | G1/4 | | | 1,5 | 10/12 | 0,42 | P2LBXL12EEHDDN |
| | G3/8 | | | 1,5 | 17/17 | 0,81 | P2LCXL13EEHDDN |
| | G1/2 | | | 1,5 | 17/17 | 0,81 | P2LDXL14EEHDDN |
|  | G1/8 | Electric signal | Spring | 3,2 | 18/40 | 0,42 | P2LAXL11ESHDDN |
| | G1/4 | | | 3,5 | 18/45 | 0,42 | P2LBXL12ESHDDN |
| | G3/8 | | | 3,5 | 25/75 | 0,76 | P2LCXL13ESHDDN |
| | G1/2 | | | 3,5 | 25/75 | 0,76 | P2LDXL14ESHDDN |
| 5/2 valves, external air to pilot operators | | | | | | | |
|  | G1/8 | Electric signal | Electric signal | 1,5 | 11/11 | 0,27 | P2LAXN11EEHDDN |
| | G1/4 | | | 1,5 | 13/13 | 0,42 | P2LBXN12EEHDDN |
| | G3/8 | | | 1,5 | 18/18 | 0,81 | P2LCXN13EEHDDN |
| | G1/2 | | | 1,5 | 18/18 | 0,81 | P2LDXN14EEHDDN |
|  | G1/8 | Electric signal | Spring | 3,2 | 15/45 | 0,22 | P2LAXN11ESHDDN |
| | G1/4 | | | 3,2 | 20/55 | 0,38 | P2LBXN12ESHDDN |
| | G3/8 | | | 3,2 | 25/85 | 0,76 | P2LCXN13ESHDDN |
| | G1/2 | | | 3,2 | 25/85 | 0,76 | P2LDXN14ESHDDN |
| 5/3 valves, external air to pilot operators | | | | | | | |
|  | G1/8 | Electric signal | Electric signal | 3,5 | 18/50 | 0,28 | P2LAXP11EEHDDN |
| | G1/4 | Closed centre | Self | 3,5 | 25/65 | 0,44 | P2LBXP12EEHDDN |
| | G3/8 | position | centring | 3,5 | 30/90 | 1,11 | P2LCXP13EEHDDN |
| | G1/2 | | | 3,5 | 30/95 | 1,11 | P2LDXP14EEHDDN |
|  | G1/8 | Electric signal | Electric signal | 3,5 | 18/50 | 0,28 | P2LAXR11EEHDDN |
| | G1/4 | Vented centre | Self | 3,5 | 25/65 | 0,44 | P2LBXR12EEHDDN |
| | G3/8 | position | centring | 3,5 | 30/90 | 1,11 | P2LCXR13EEHDDN |
| | G1/2 | | | 3,5 | 30/95 | 1,11 | P2LDXR14EEHDDN |
|  | G1/8 | Electric signal | Electric signal | 3,5 | 18/50 | 0,28 | P2LAXQ11EEHDDN |
| | G1/4 | Pressurised | Self | 3,5 | 25/65 | 0,44 | P2LBXQ12EEHDDN |
| | G3/8 | centre | centring | 3,5 | 30/90 | 1,11 | P2LCXQ13EEHDDN |
| | G1/2 | position | | 3,5 | 30/95 | 1,11 | P2LDXQ14EEHDDN |

Dimensions

P2LAX... all
3/2 valves

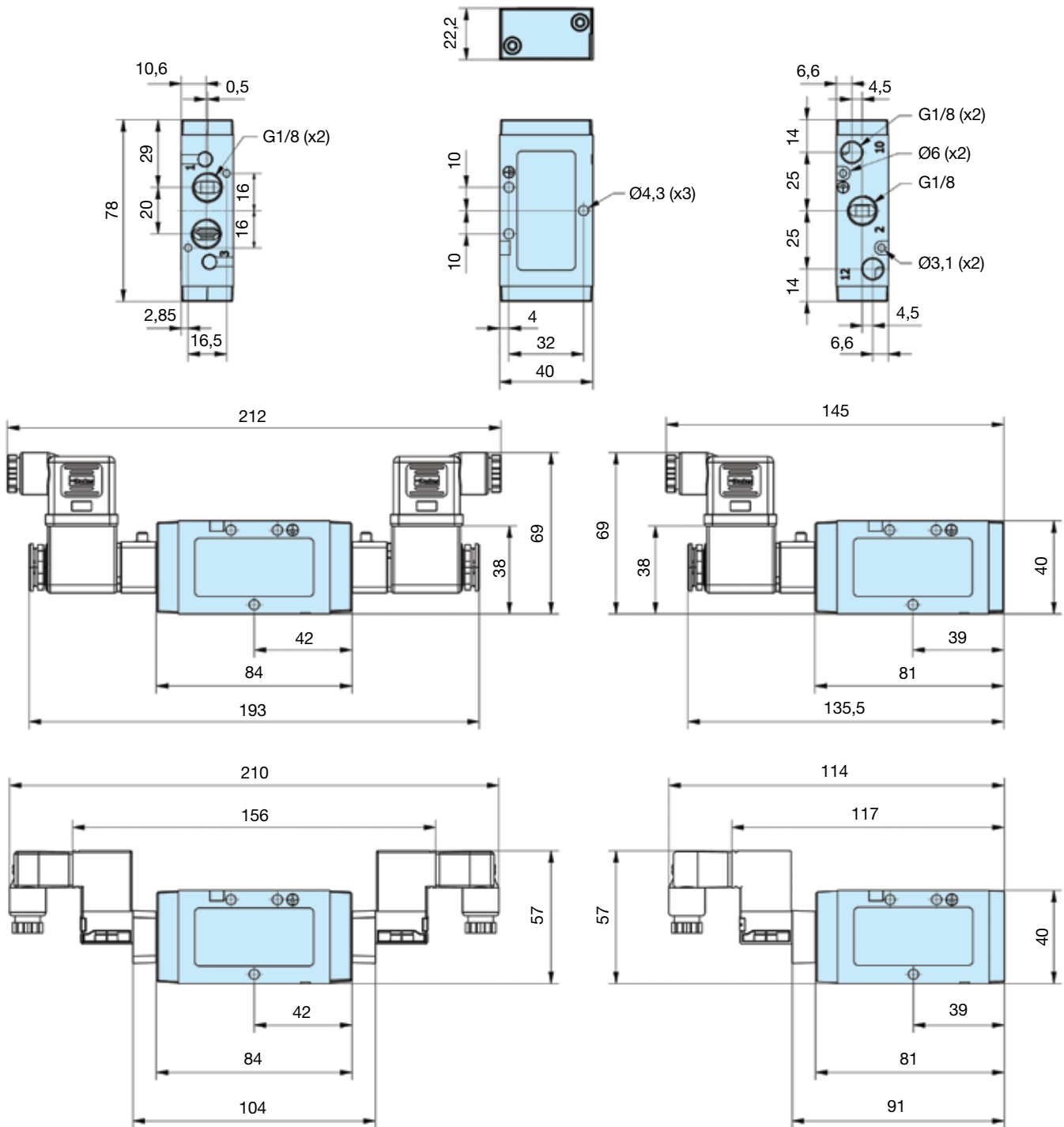

Solenoid valves

Cable plugs must be ordered separately.

One pilot valve is required for each E in the valve order code.

Dimensions

P2LAX... all
5/2 and 5/3 valves

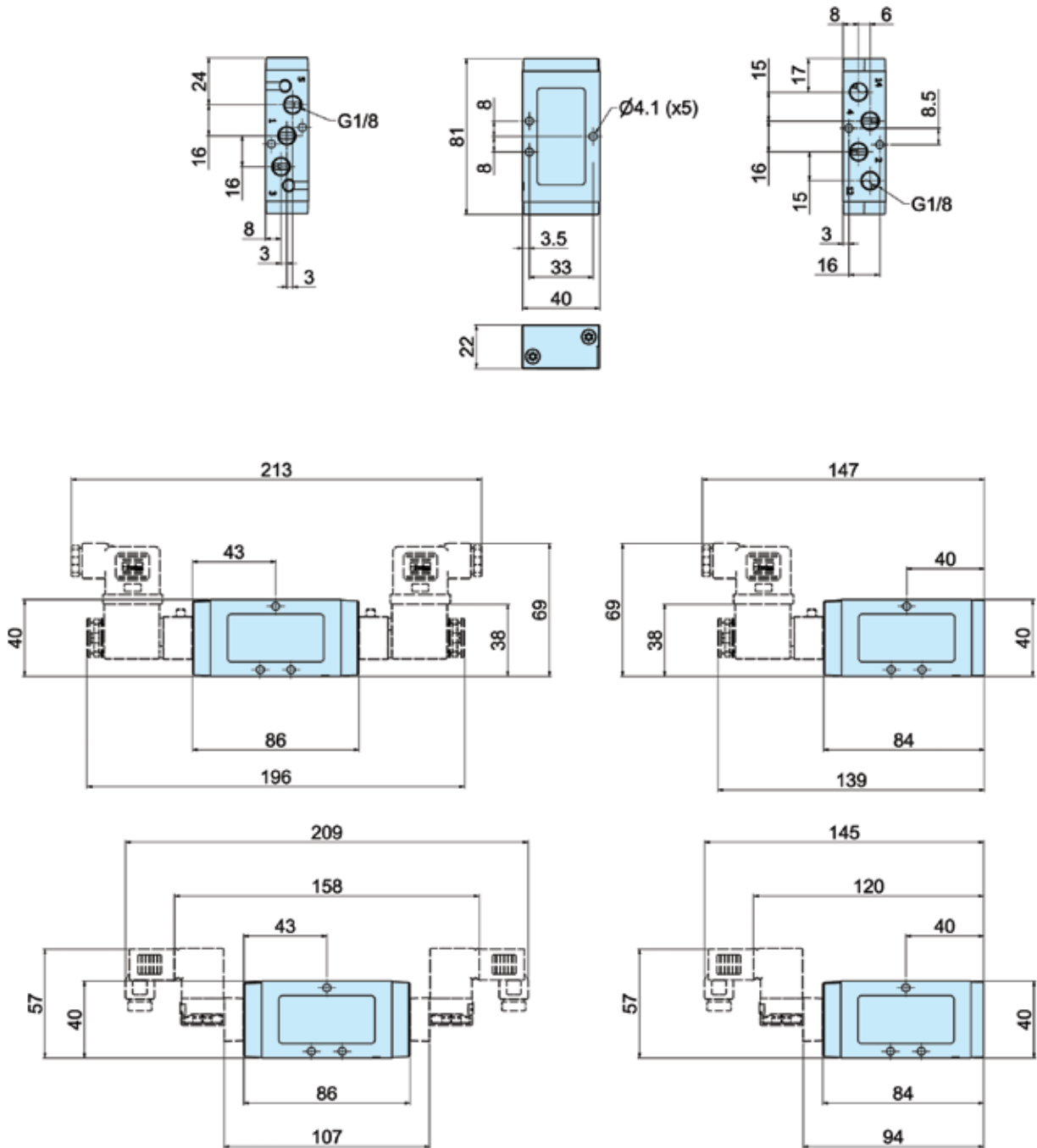

Solenoid valves
Cable plugs must be ordered separately.
One pilot valve is required for each E in the valve order code.

Dimensions

P2LAX - 3/2 Lever operated directional control valves

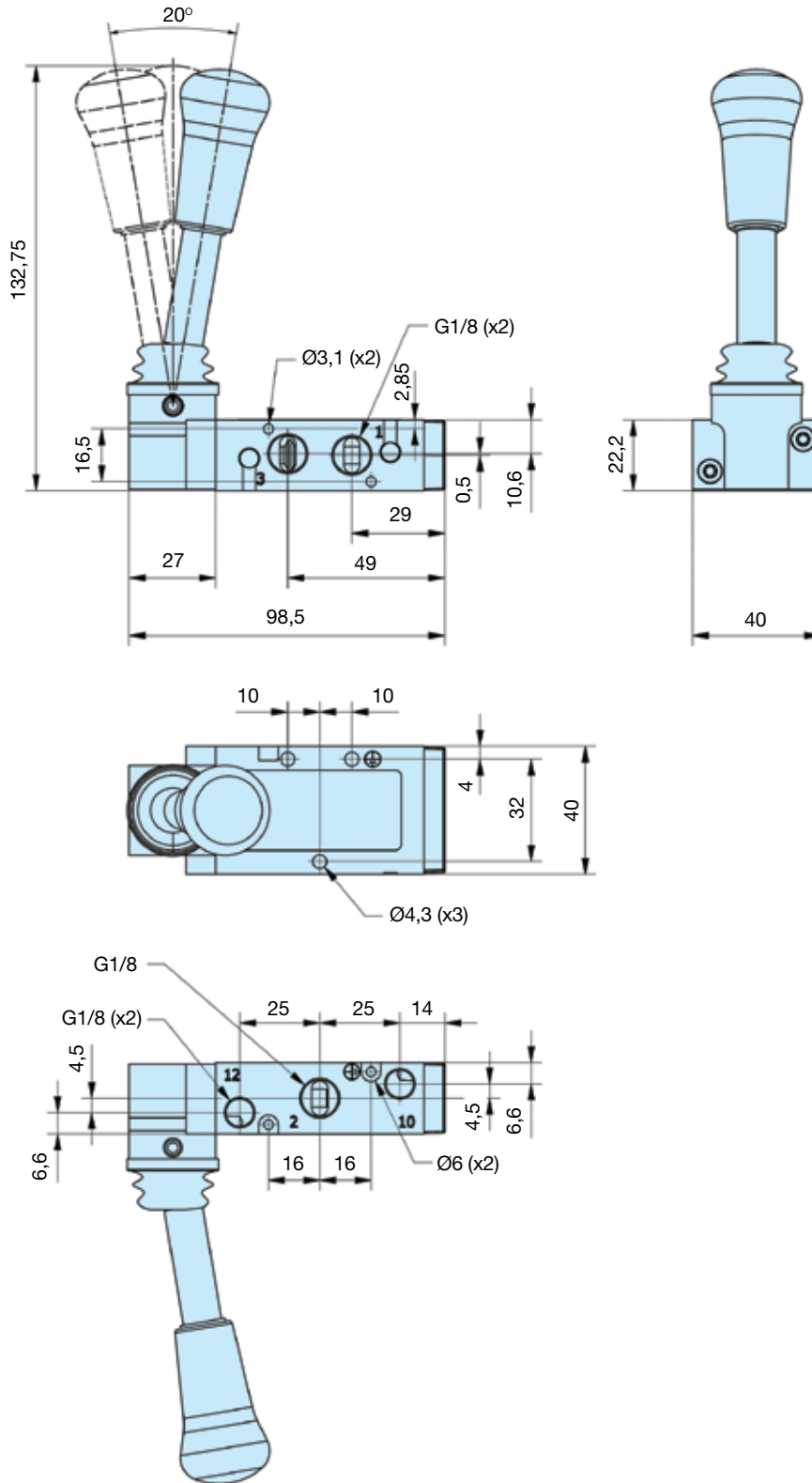

Dimensions

P2LAX - 5/2 & 5/3 Lever operated directional control valves

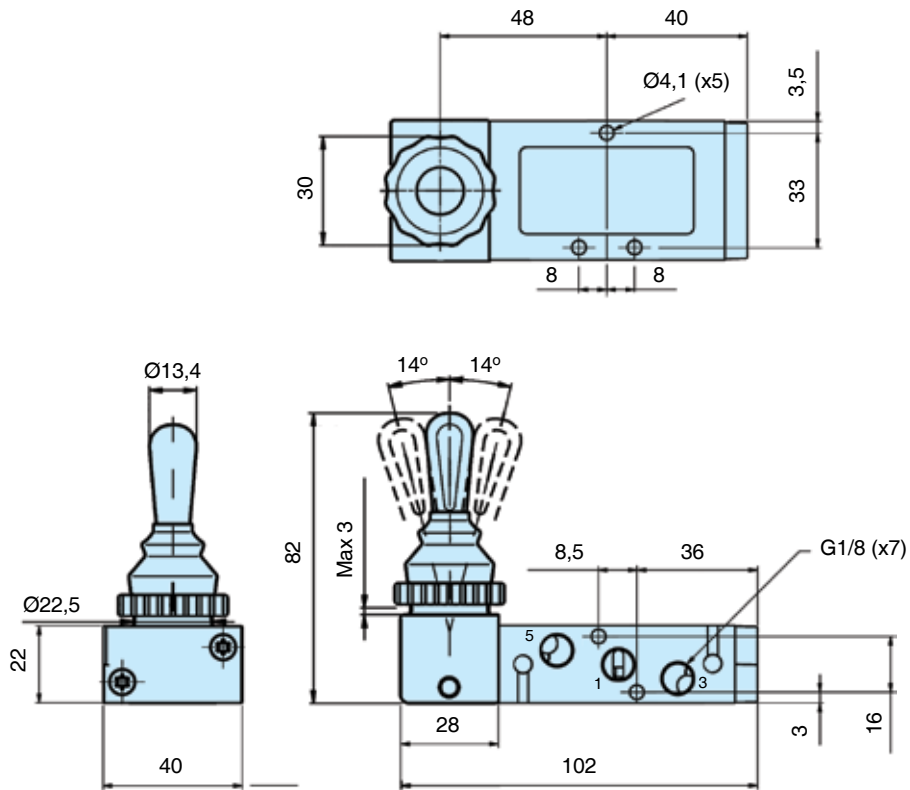

Dimensions

P2LBX - 3/2 Lever operated directional control valves

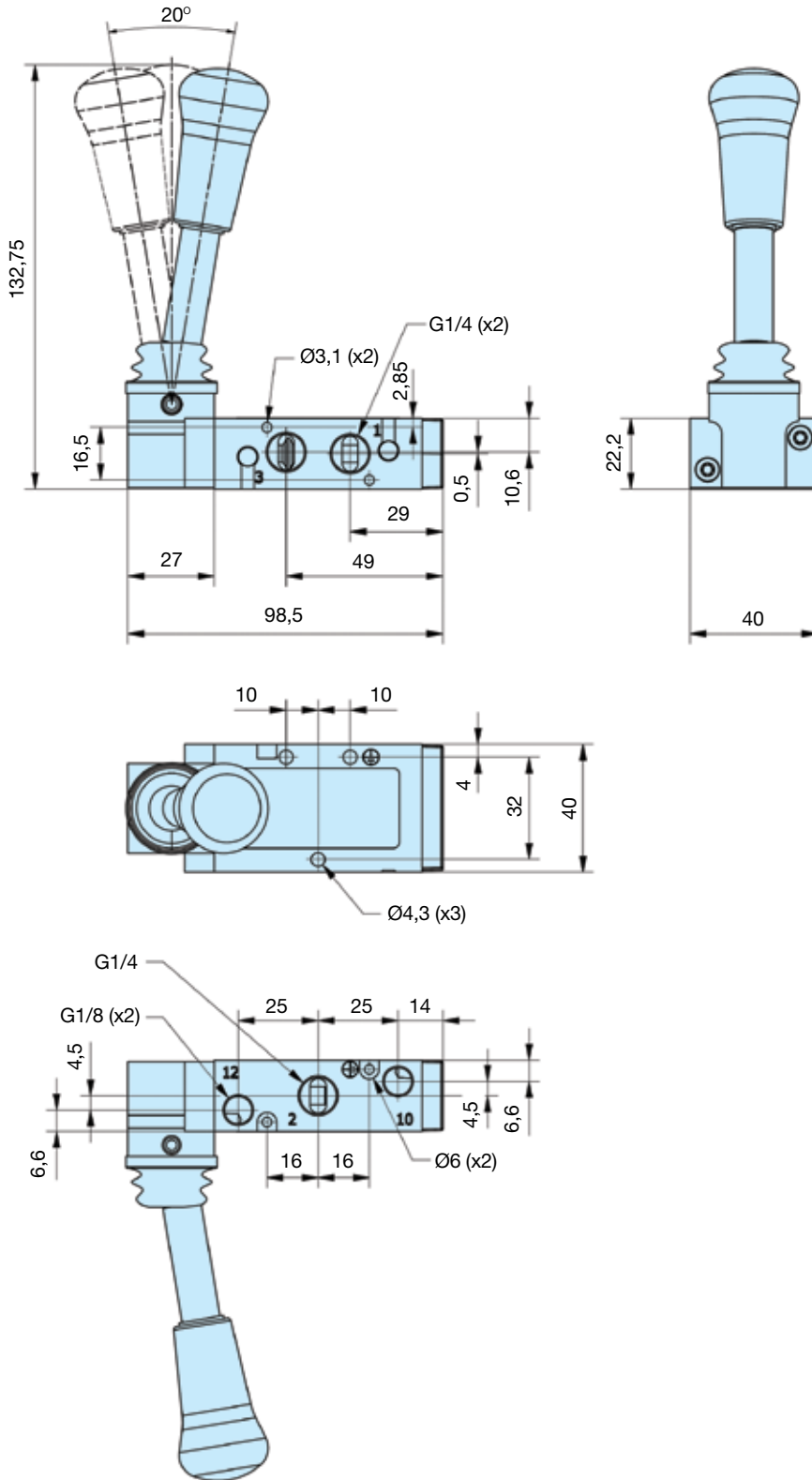

Dimensions

P2LBX - 5/2 Lever operated directional control valves

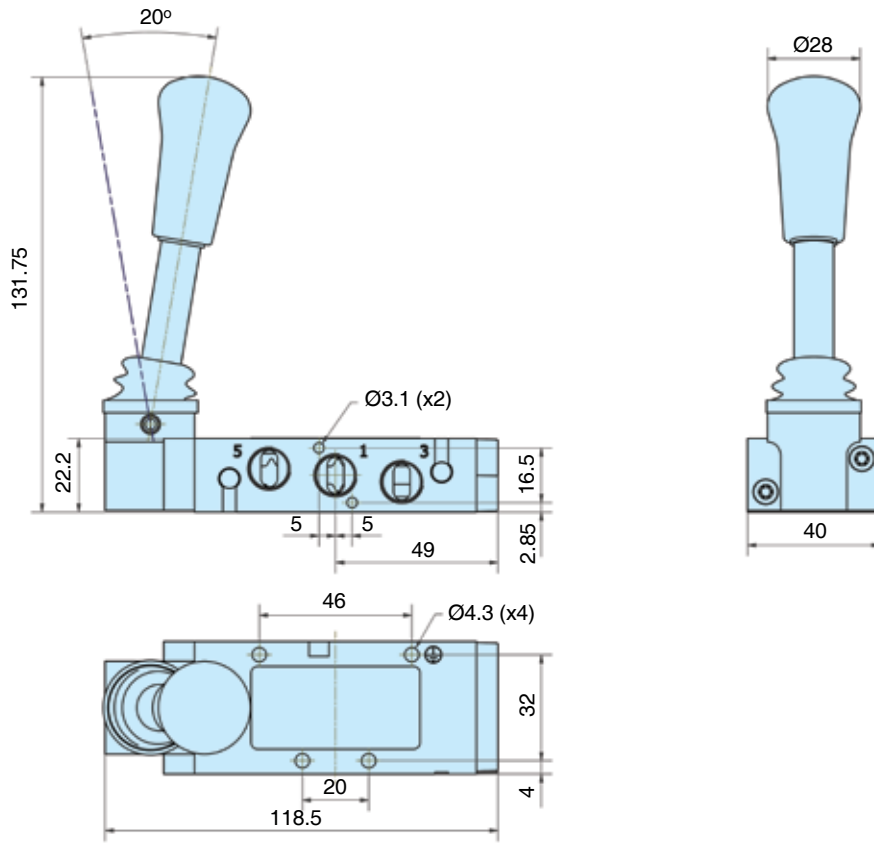

P2LBX - 5/3 Lever operated directional control valves

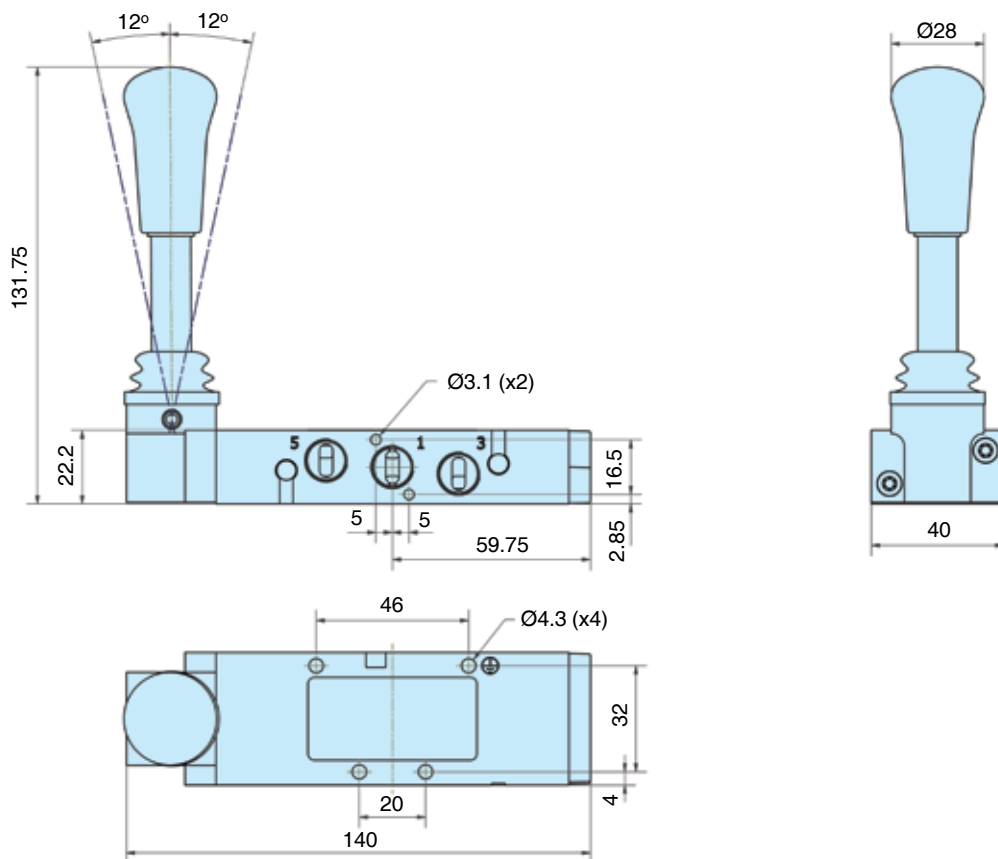

Dimensions

P2LCX - 3/2 Lever operated directional control valves

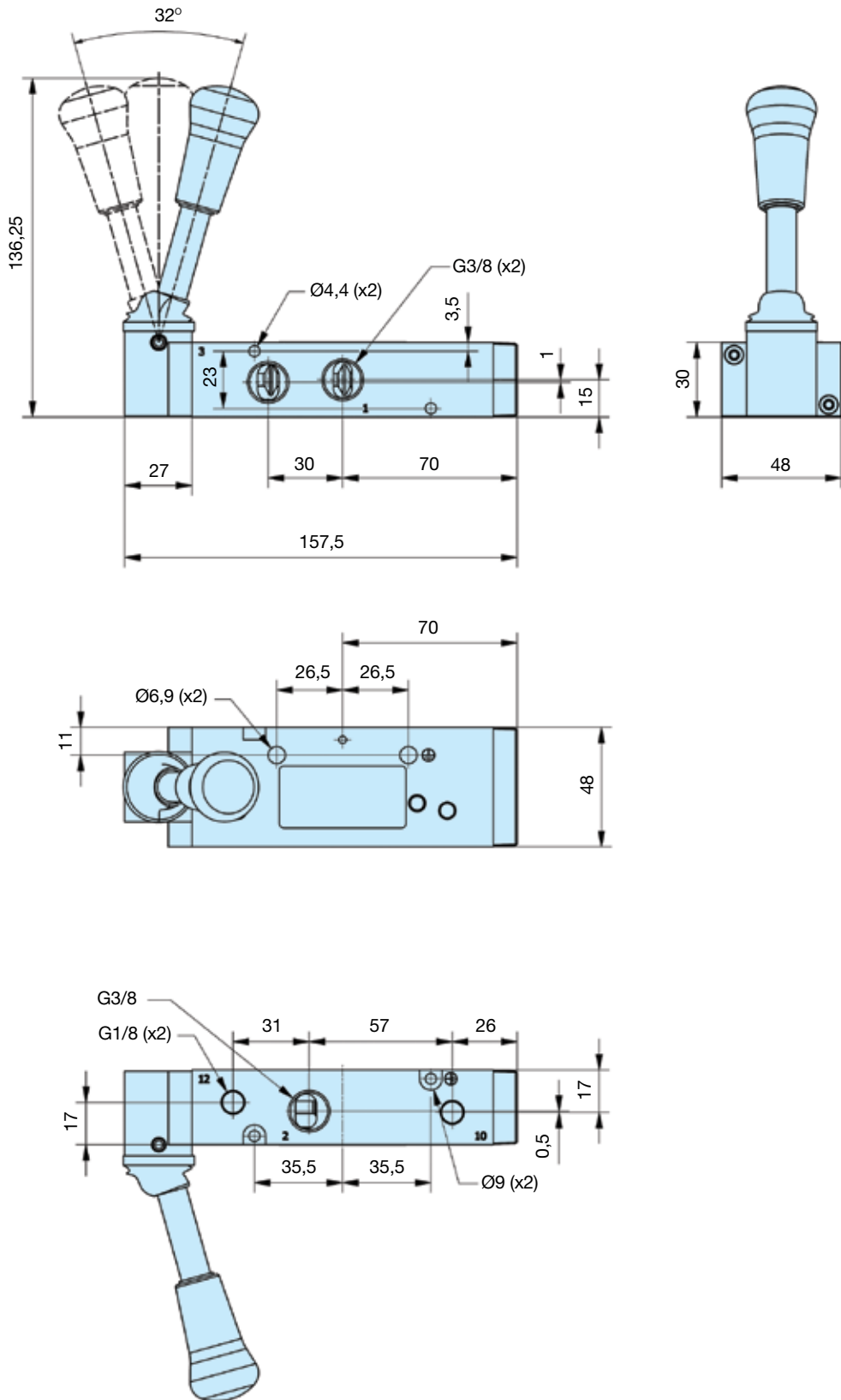

Dimensions

P2LCX - 5/2 Lever operated directional control valves

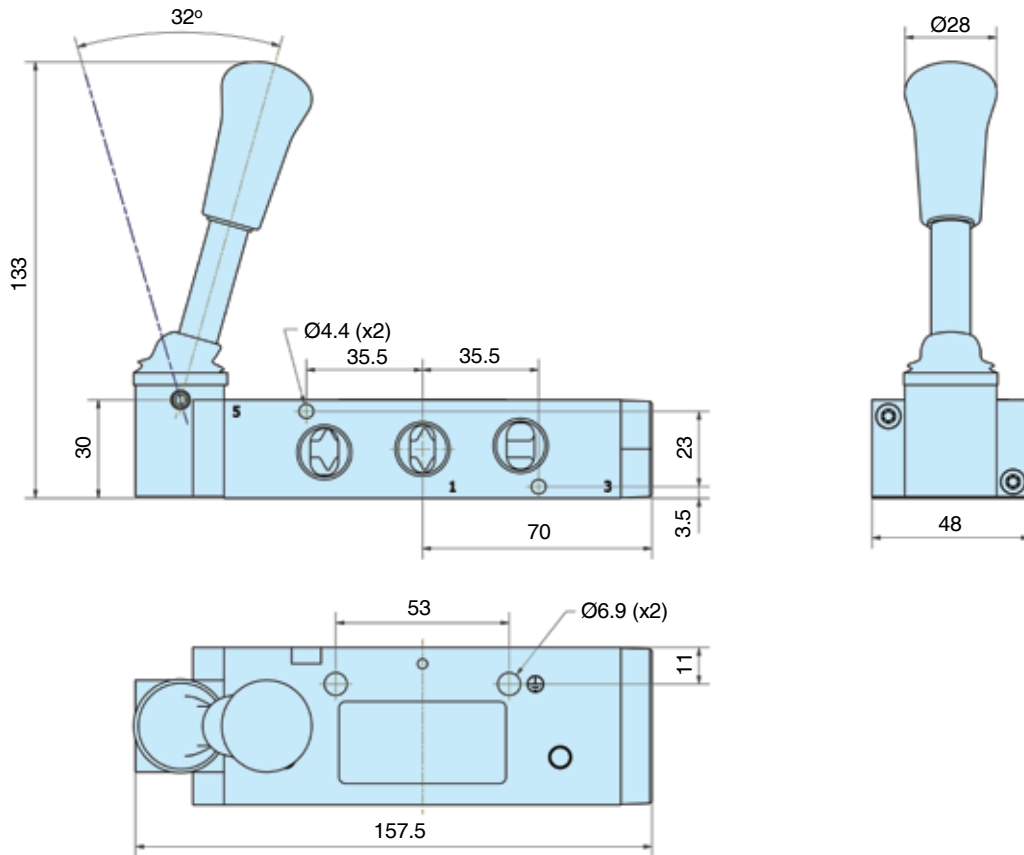

P2LCX - 5/3 Lever operated directional control valves

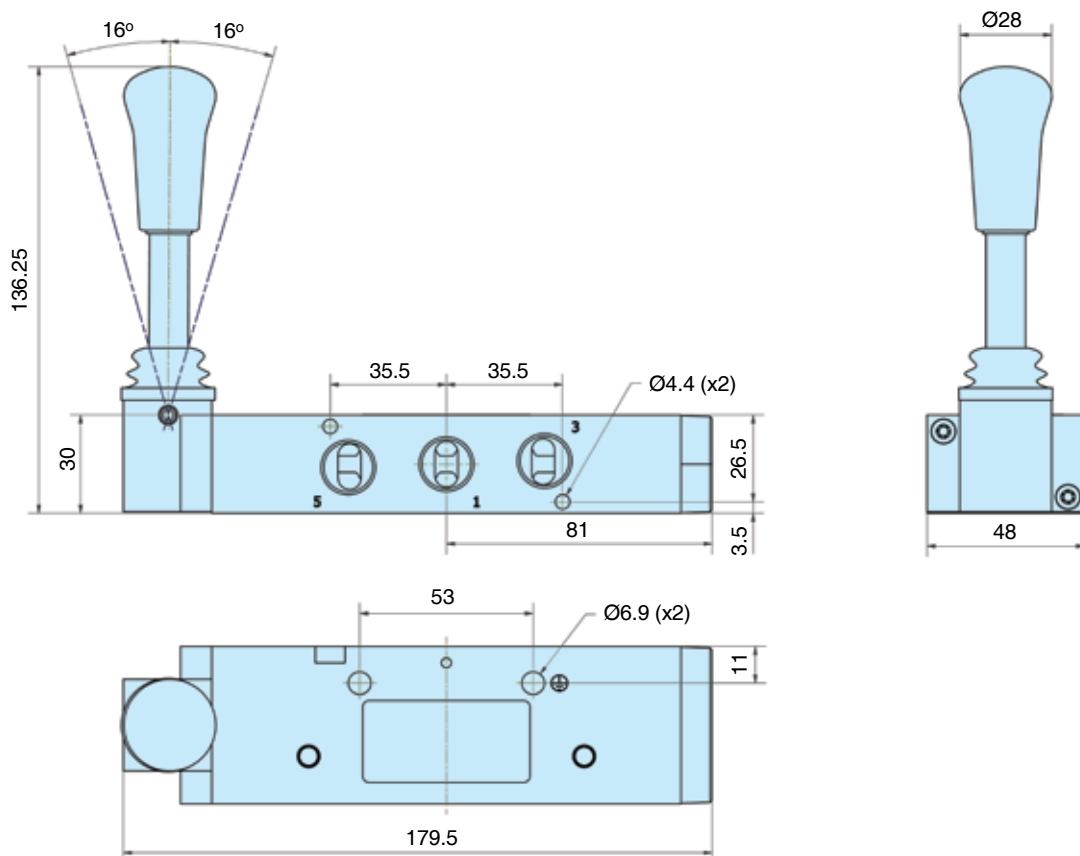

Dimensions

P2LDX - 3/2 Lever operated directional control valves

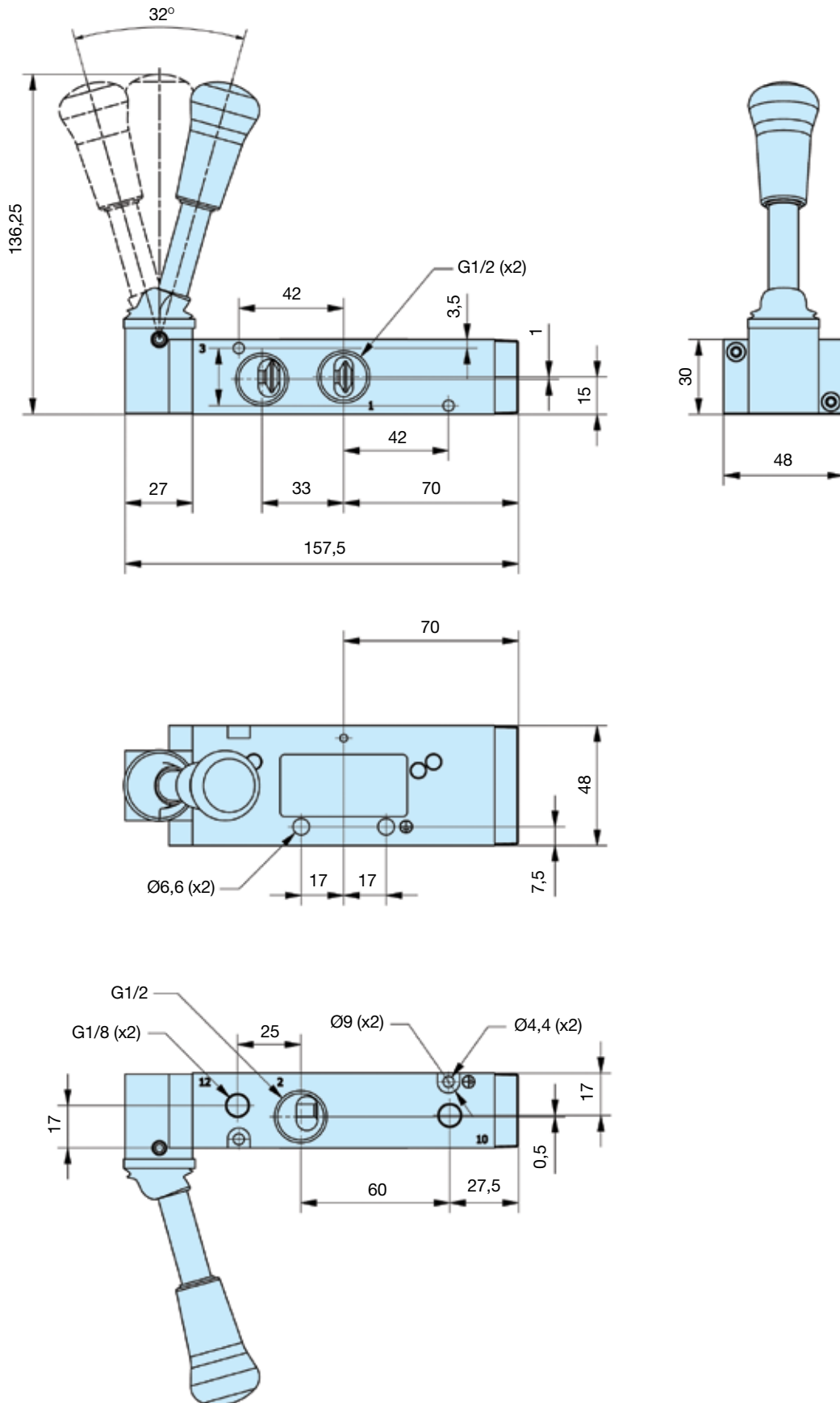

Dimensions

P2LDX - 5/2 Lever operated directional control valves

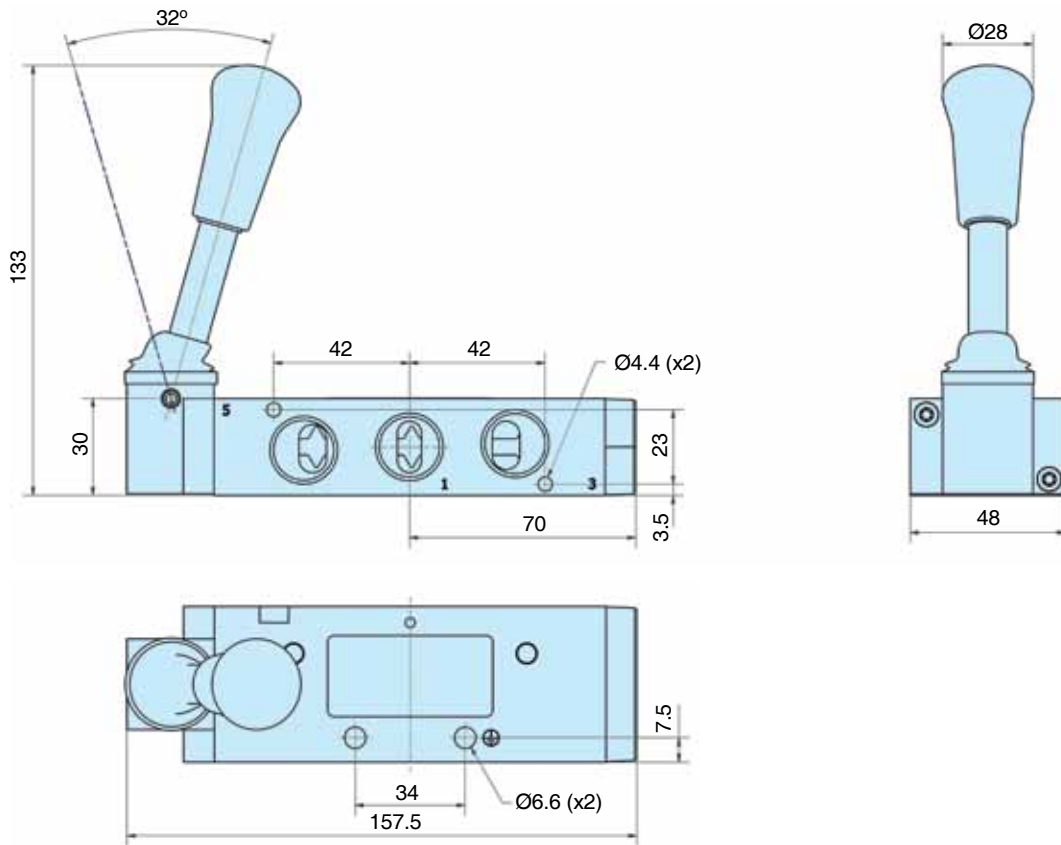

P2LDX - 5/3 Lever operated directional control valves

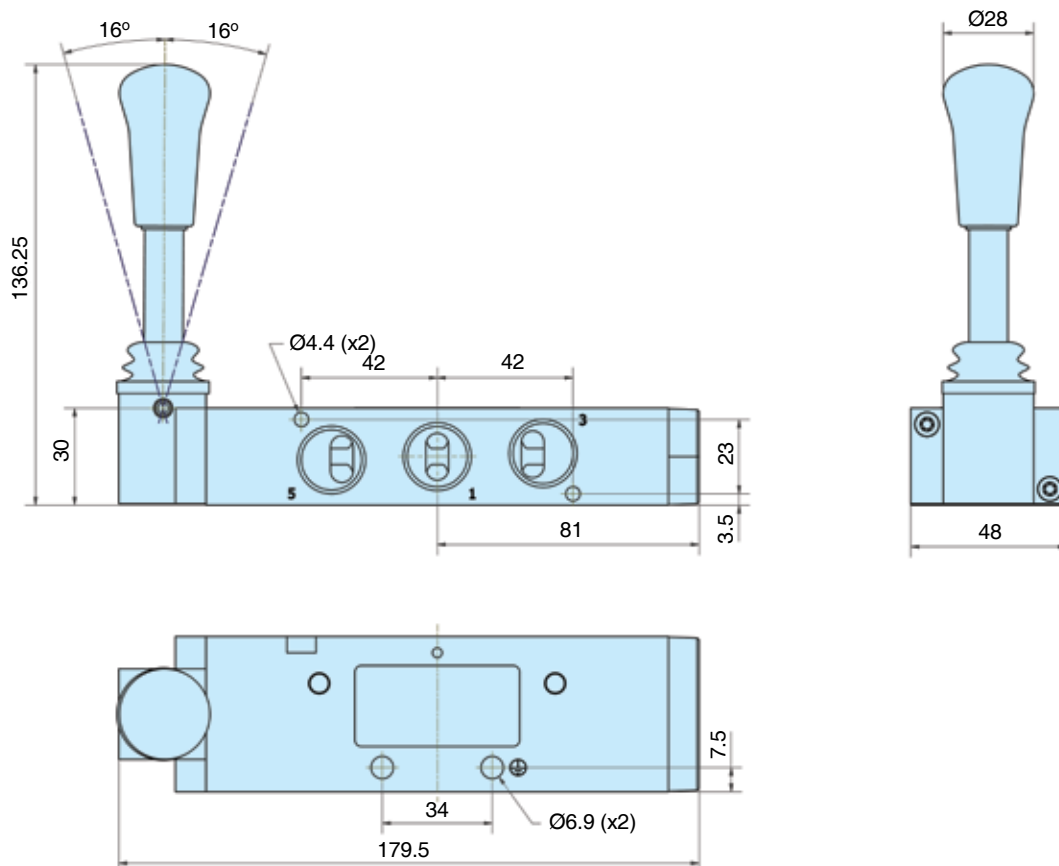

Dimensions

P2LBX - 3/2 Twist operated directional control valves

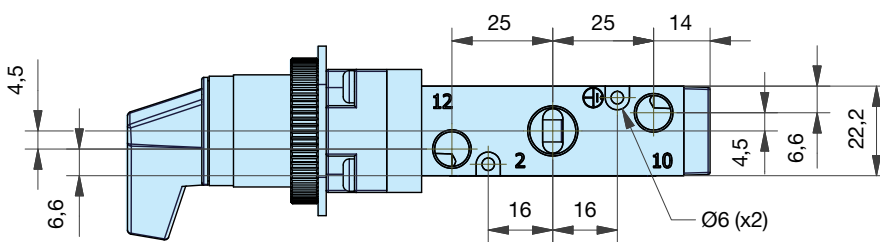
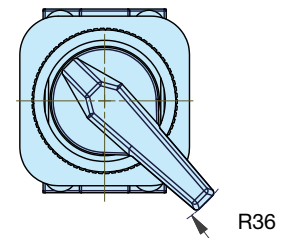
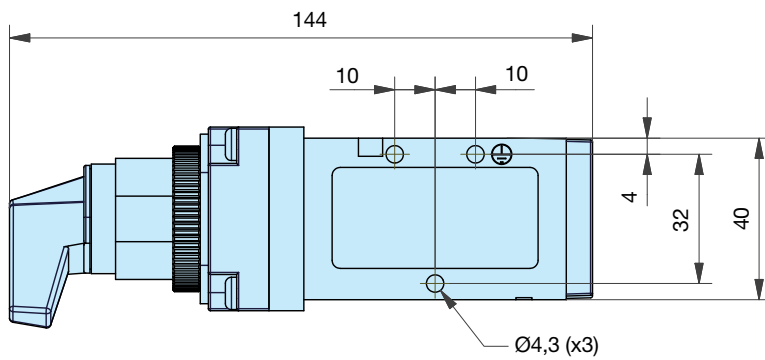
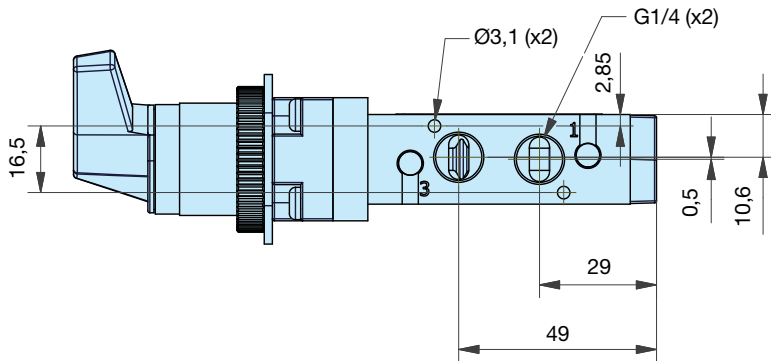

Panel cut-out details

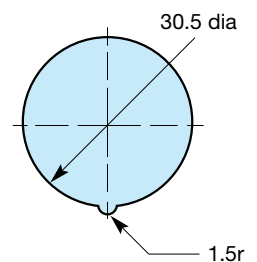
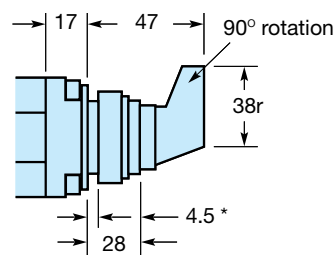

* Max panel thickness

Dimensions

P2LBX - 5/2 Twist operated directional control valves

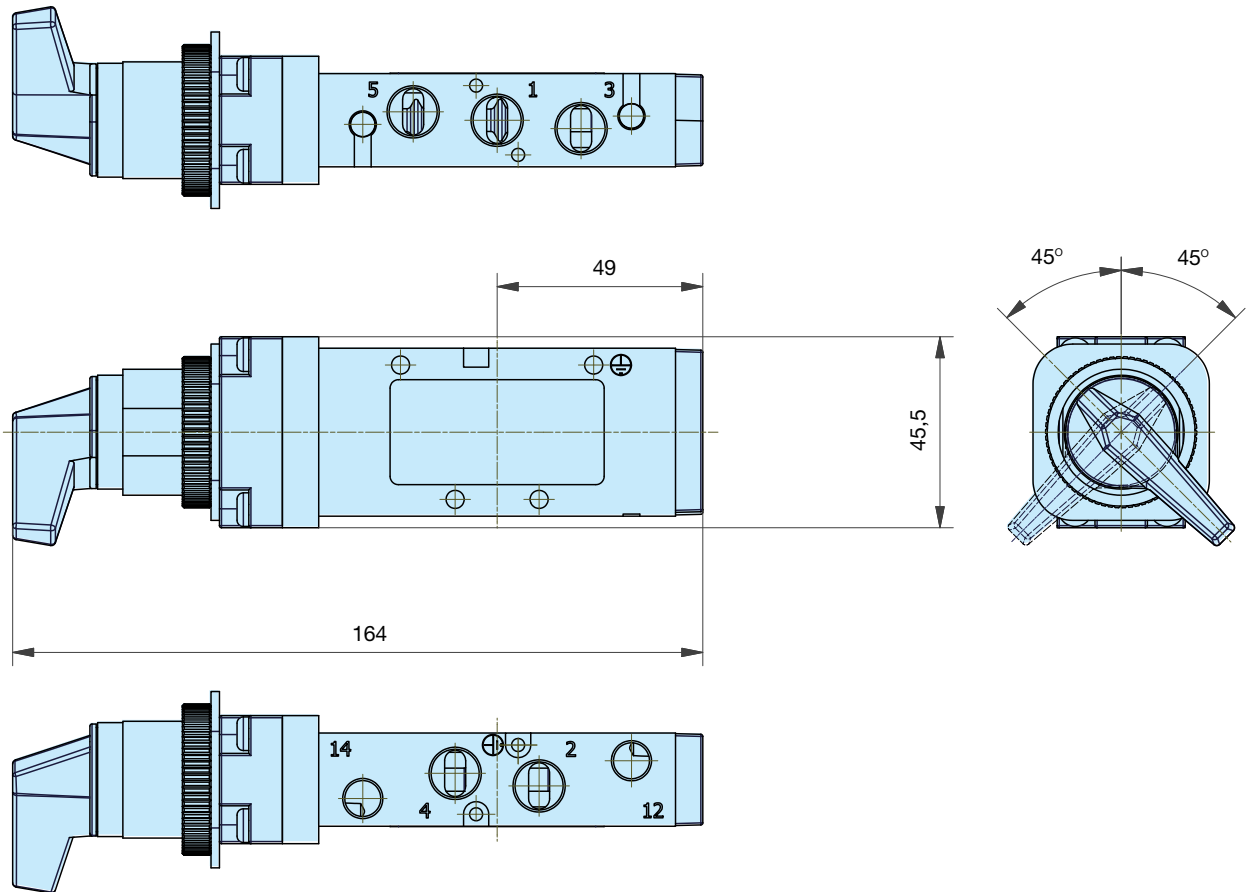

Dimensions

P2LBX - 5/3 Twist operated directional control valves

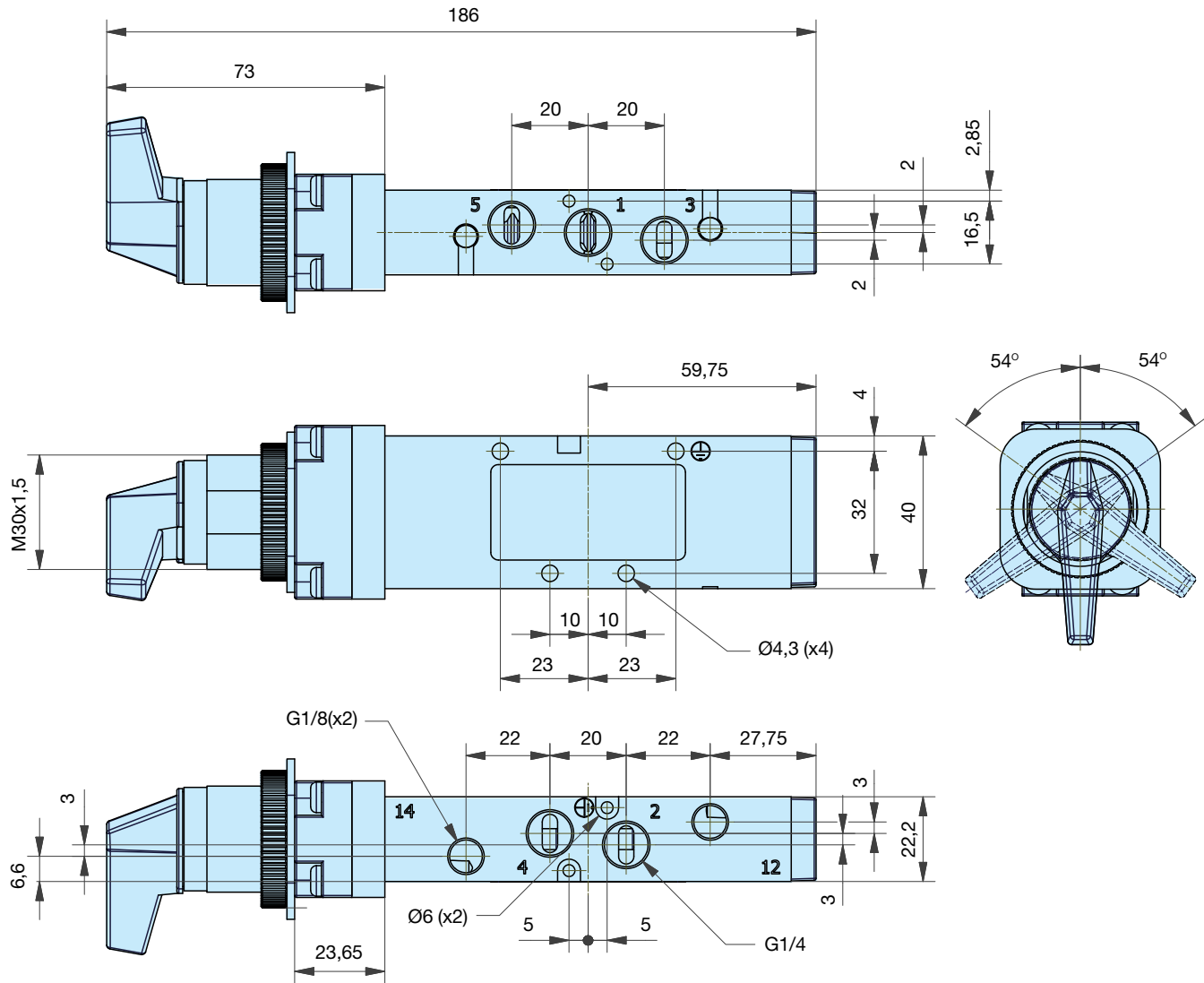

Dimensions

P2LBX... all
 3/2 valves

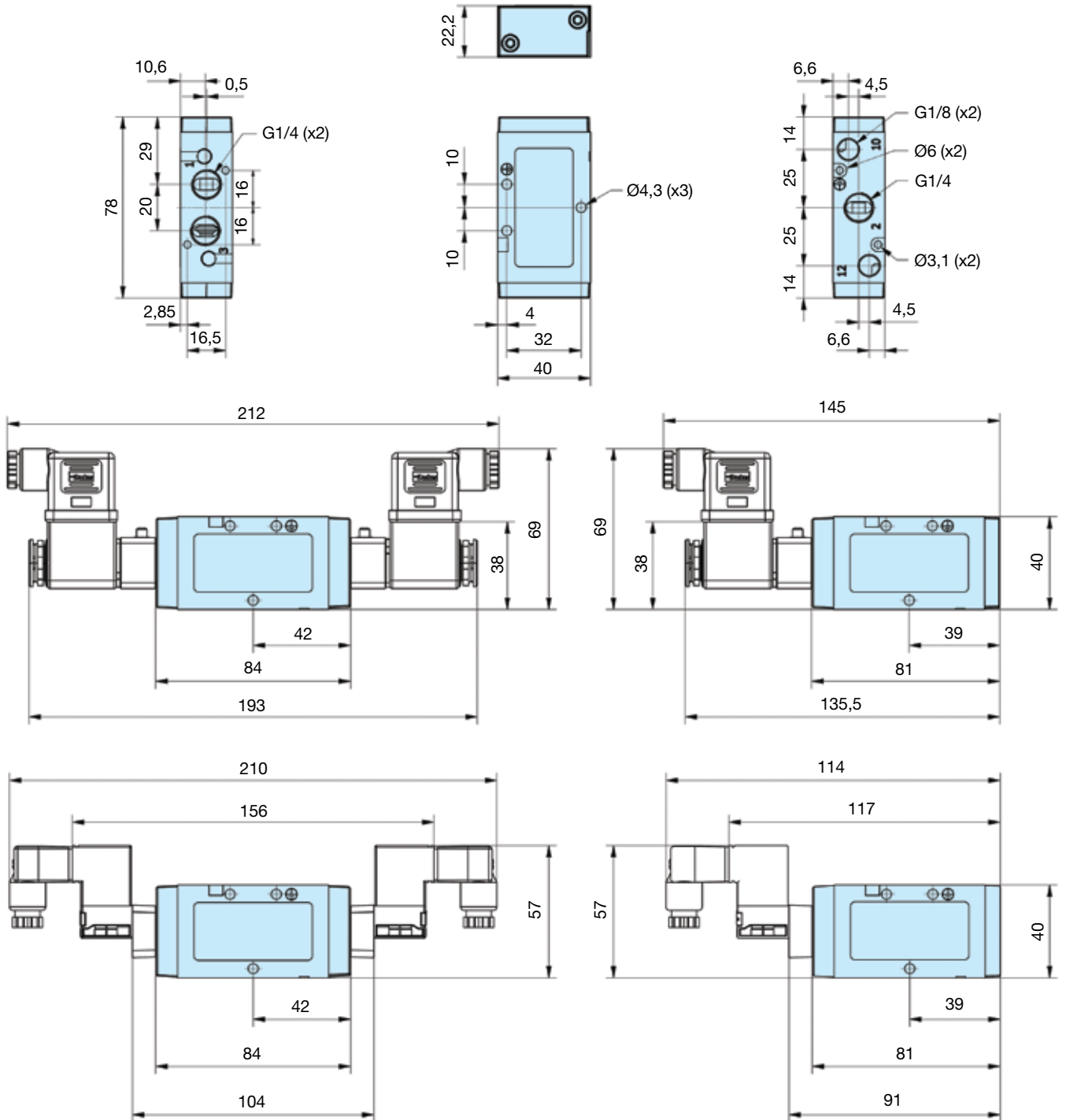

Dimensions

P2LBX... all

5/2 and 5/3 valves

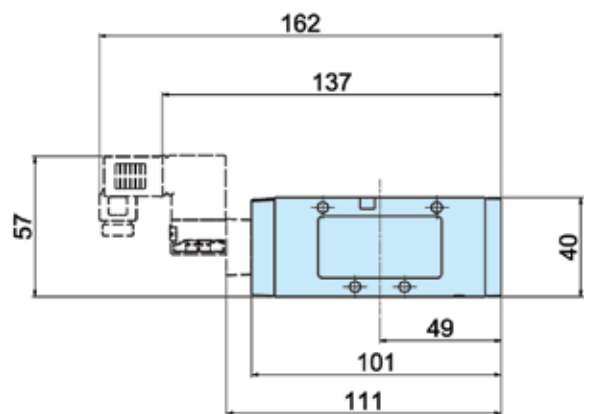
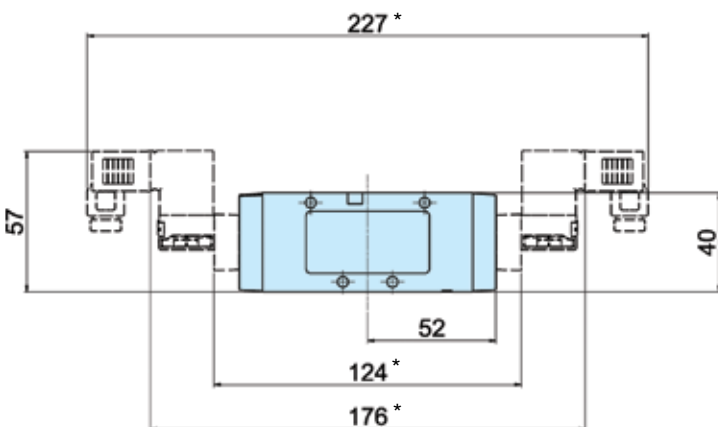
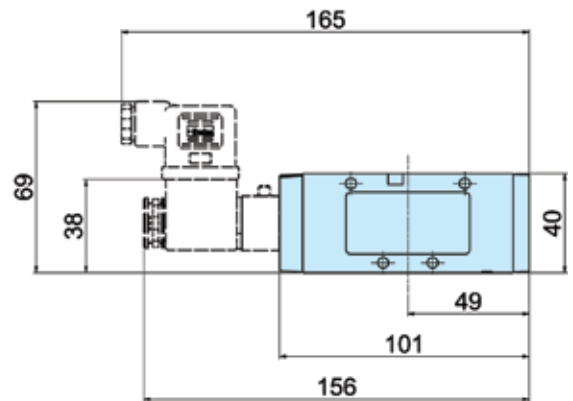
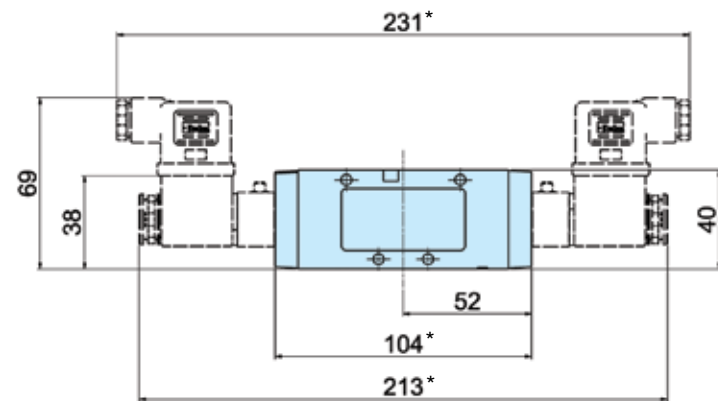
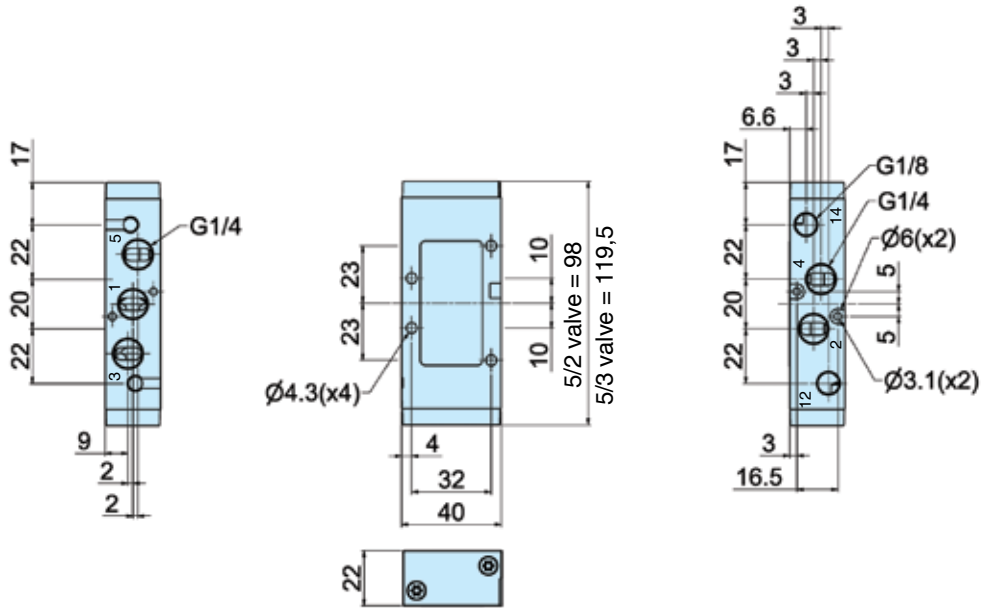

* Note: 5/3 valves - add 21.5mm

Dimensions

**NAMUR
 5/2 valves**

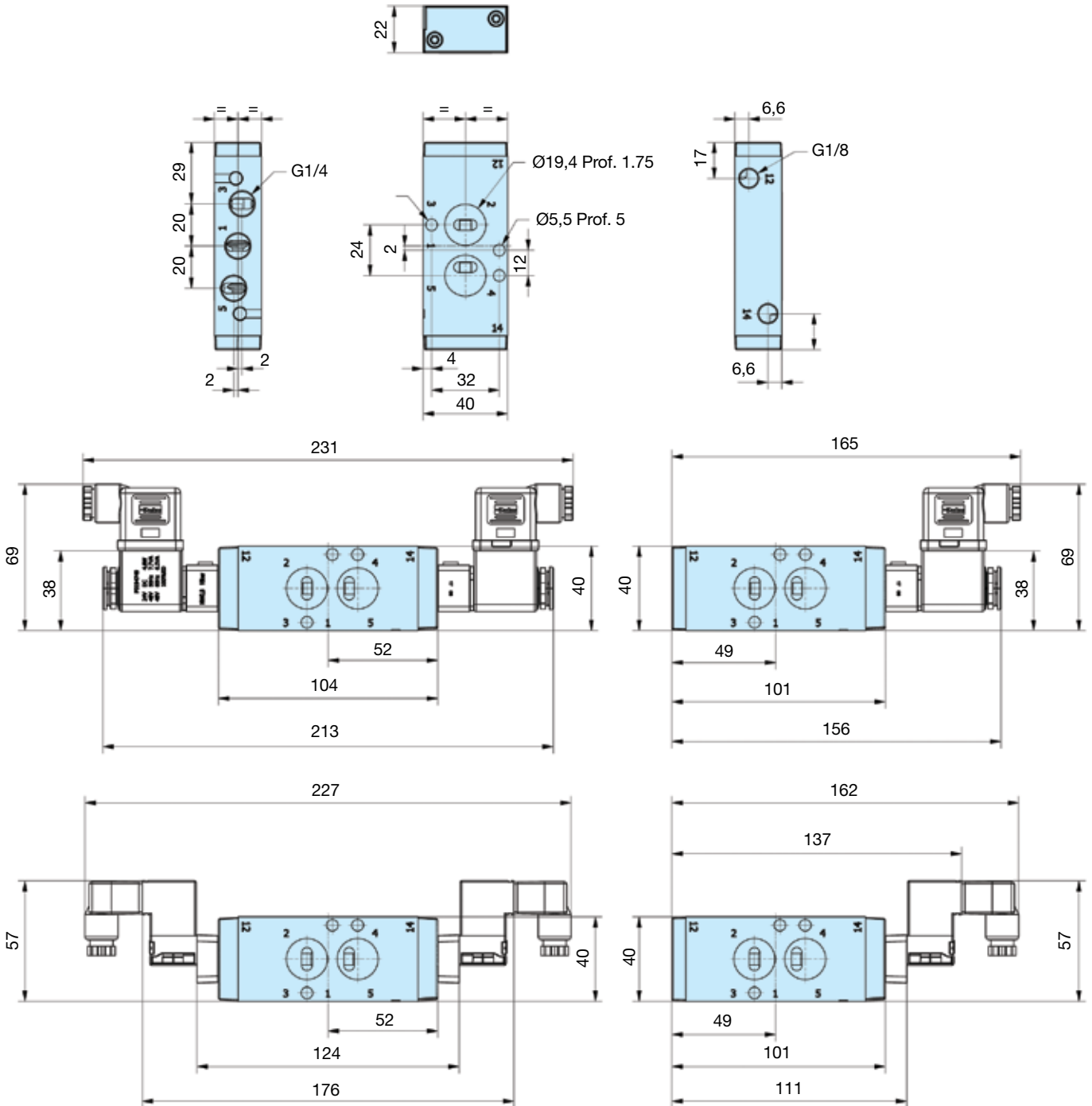

Dimensions

P2LCX... all
3/2 valves

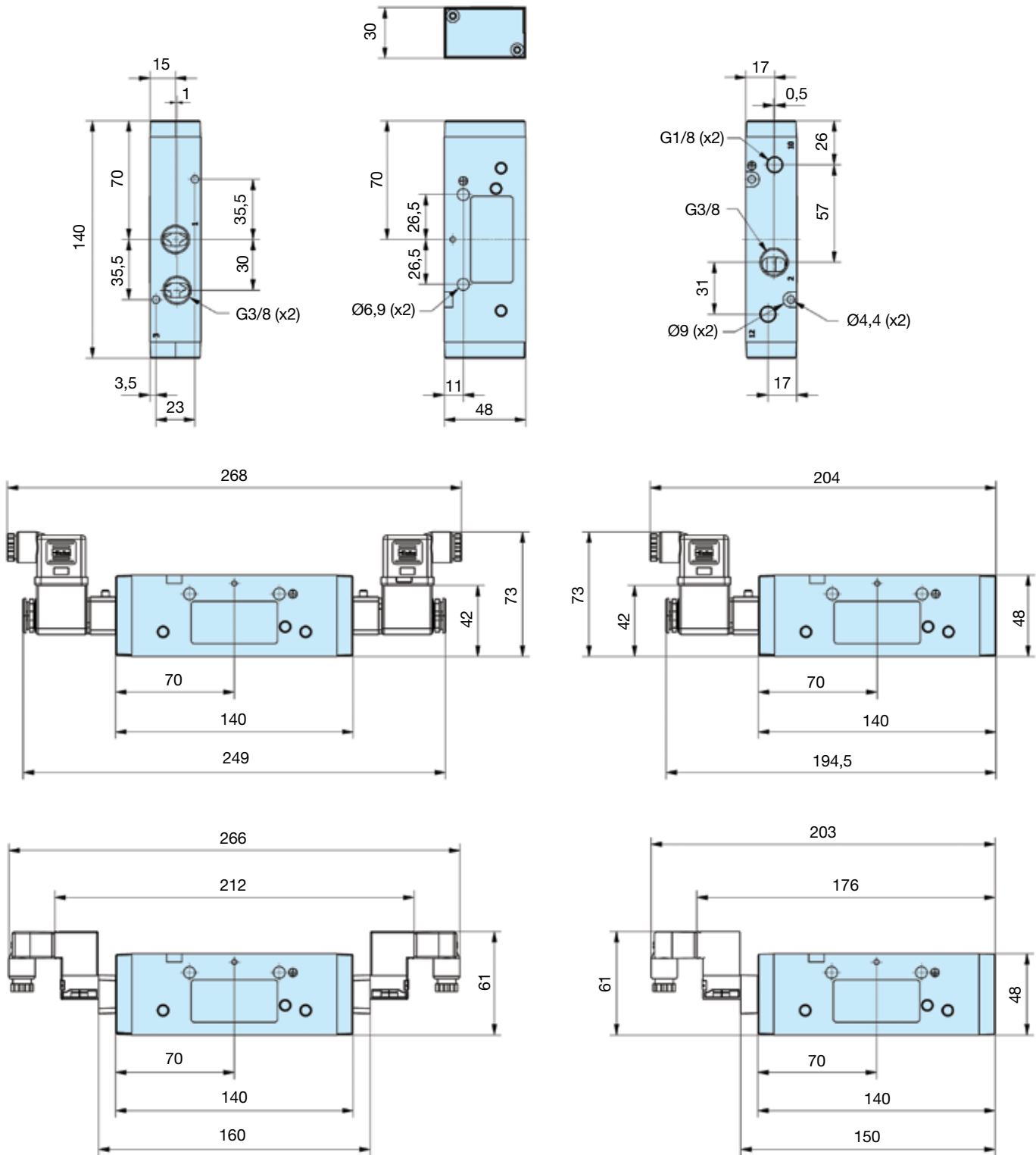

Dimensions

P2LCX... all
5/2 and 5/3 valves

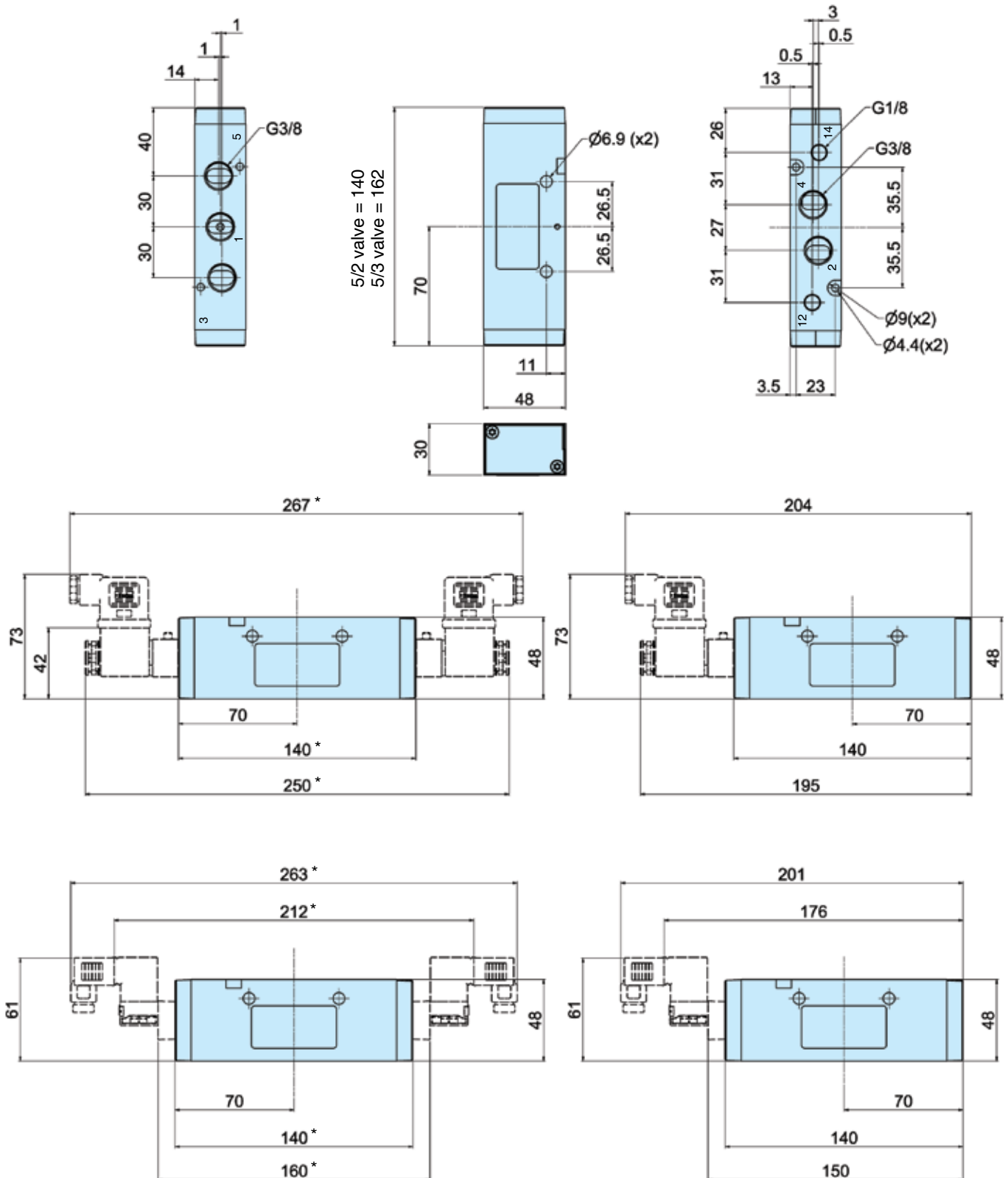

* Note: 5/3 valves - add 22.0mm

Dimensions

P2LDX... all
3/2 valves

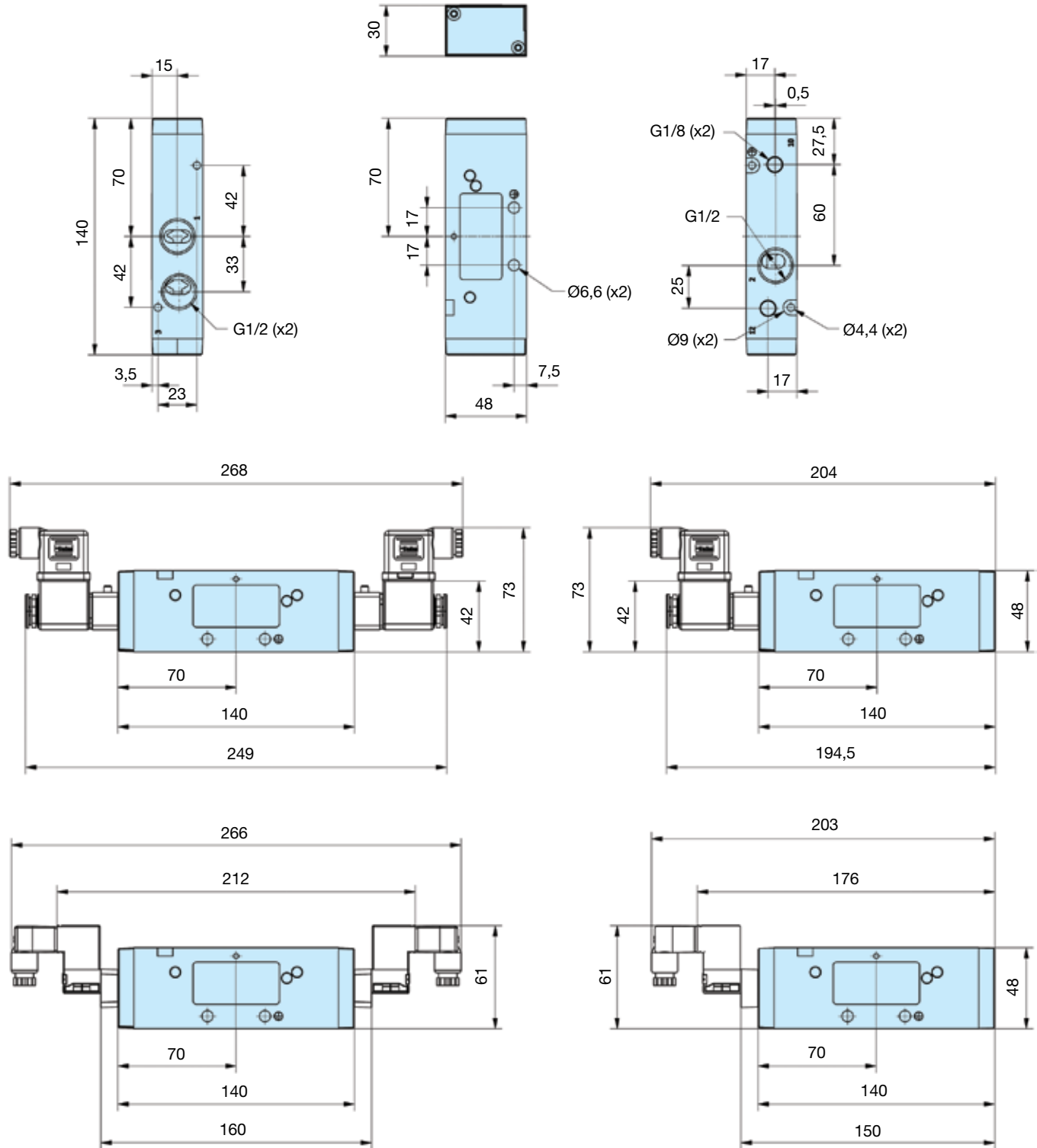

Dimensions

P2LDX... all

5/2 and 5/3 valves

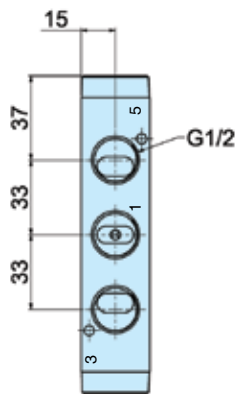

5/2 valve = 140
5/3 valve = 162

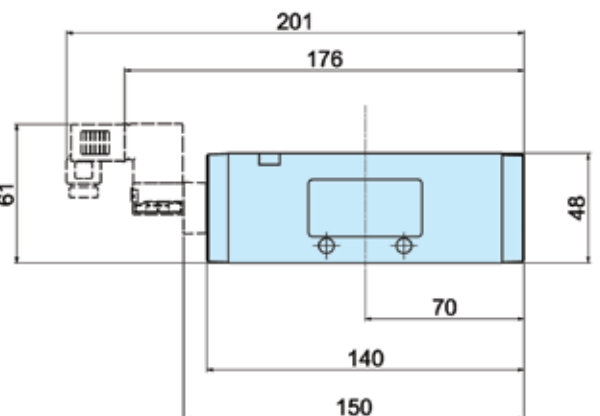
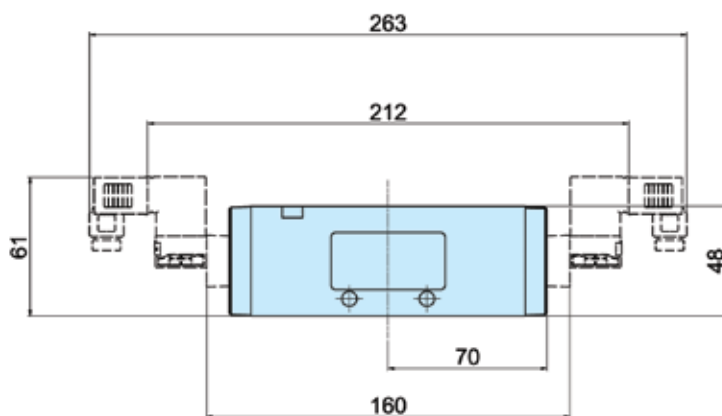
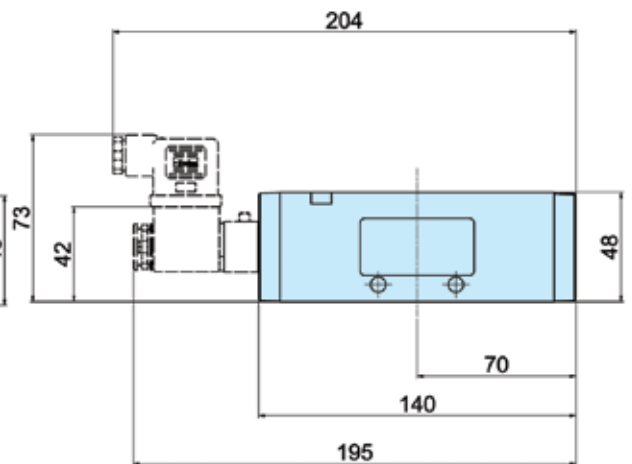
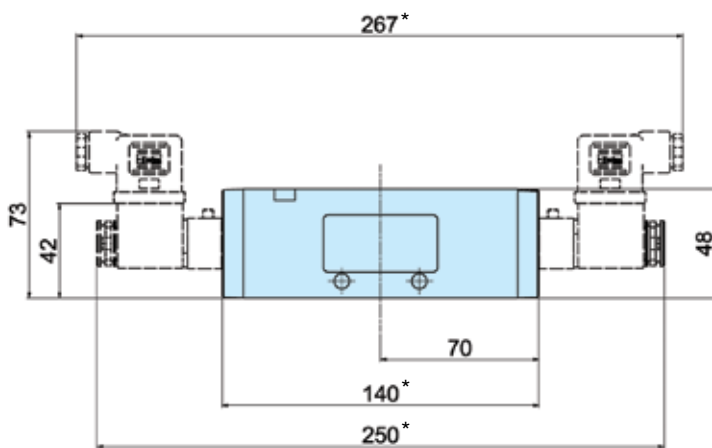
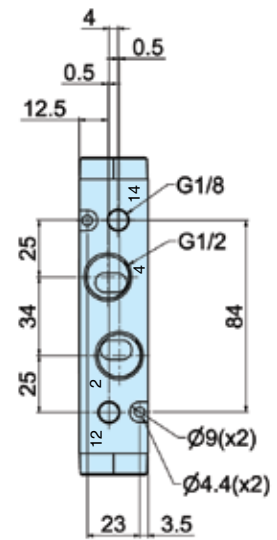
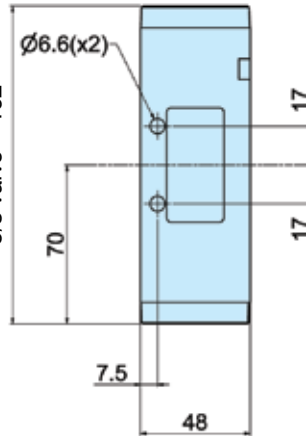

* Note: 5/3 valves - add 22.0mm

Dimensions

NAMUR

5/2 and 5/3 valves

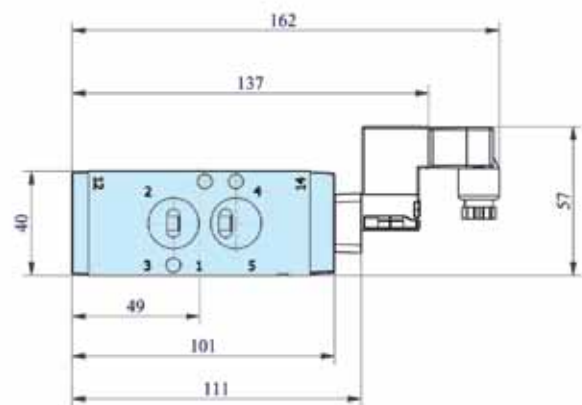
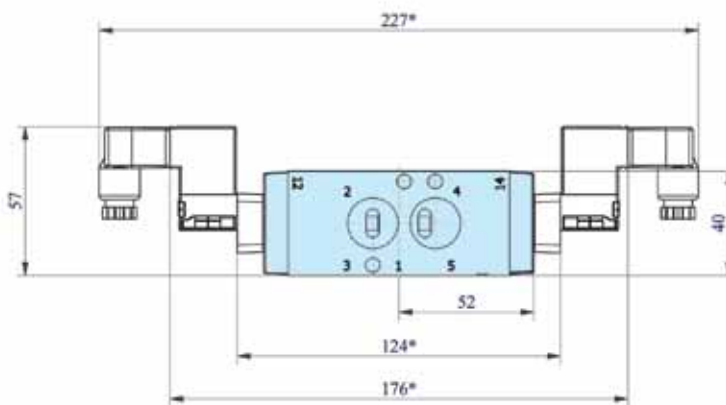
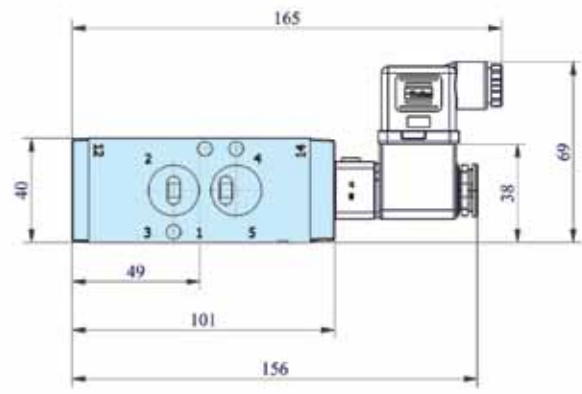
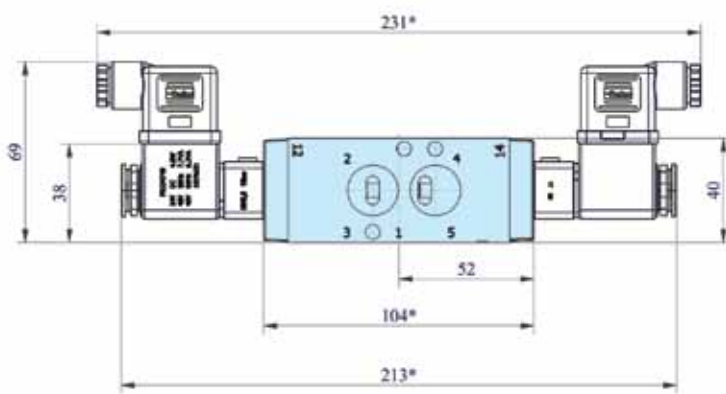
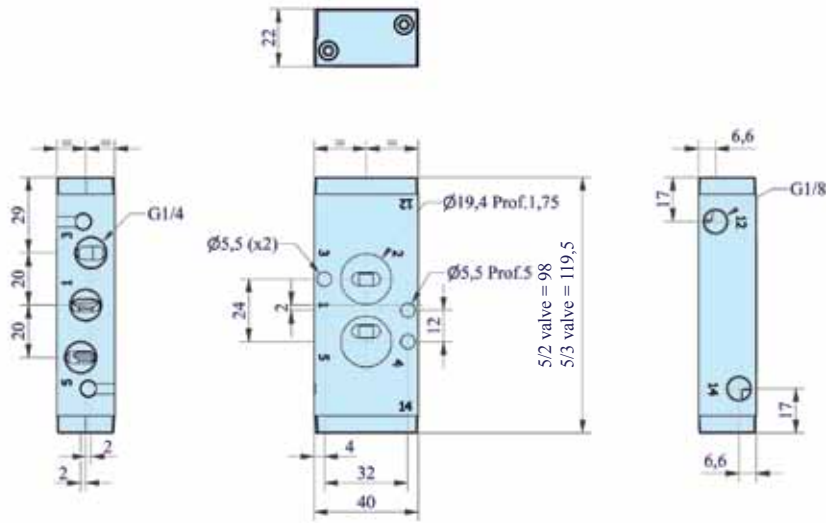

P2LAX, flexible manifold assembly

A practical system solution with the aid of connection pieces. The manifolds can easily be assembled from the top to form a compact and stable block. The block can then be installed in cabinets or directly on the machine frame as shown in the example in the bottom of this page.

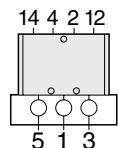

Valve:
with cylinder ports 2 and 4 and signal ports 12 and 14 facing upwards, enabling easily access to connection ports. All ports are G1/8 threaded to simplify choice of connectors.

Manifold:
with common channels for ports 1, 3 and 5.

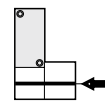
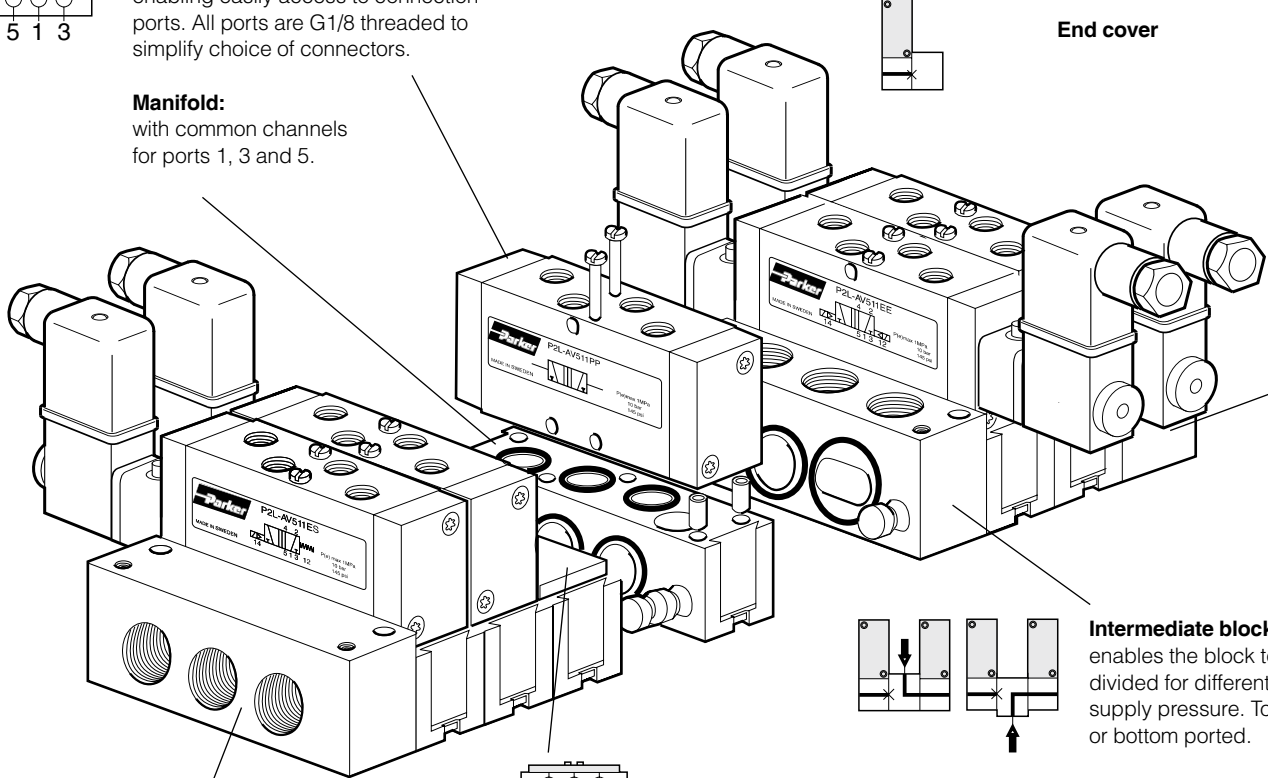

Connection block S:
straight connection block with a side ports for common air supply and exhaust.

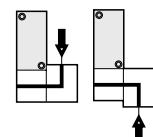

Connection block L:
angled connection block for top or bottom ported.

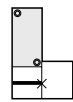

End cover

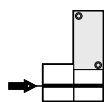

Connection block S:
straight connection block with a side ports for common air supply and exhaust.

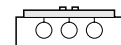

Blanking plate:
To incorporate spare positions.

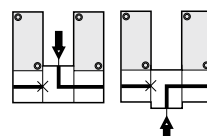

Intermediate block L:
enables the block to be divided for different supply pressure. Top or bottom ported.

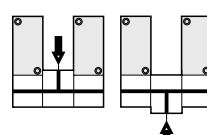

Intermediate block T:
permits the connection of air between two manifolds. Top or bottom ports.

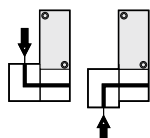

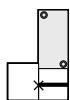

Connection block L:
angled connection block for top or bottom ported.

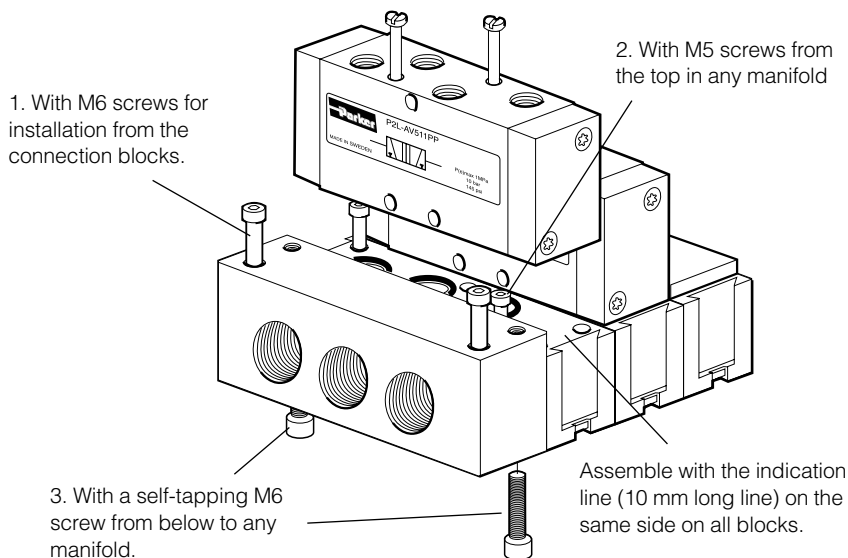

End cover

Various mounting options

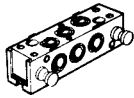
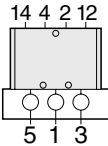
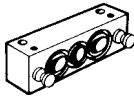
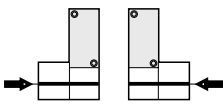
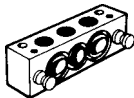
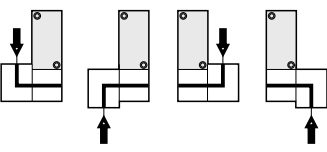
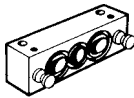
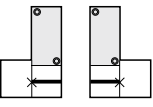
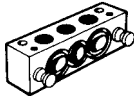
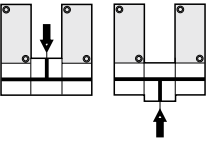
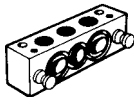
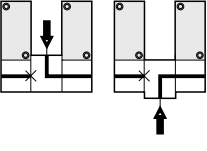

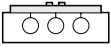
| Accessories P2LA | Connection alternatives | Type | Weight kg | Order code |
|--|---|---|--------------|-------------------|
|  |  | <p>Multiple manifold including seals, mounting screws, and guiding pins.</p> | 0,11 | 9121658060 |
|  |  | <p>Connection block S including seals, mounting screws, and guiding pins. G1/4</p> | 0,15 | 9121658064 |
|  |  | <p>Connection block L including seals, mounting screws, and guiding pins. G1/4</p> | 0,15 | 9121658061 |
|  |  | <p>End cover including seals, mounting screws, and guiding pins.</p> | 0,16 | 9121658066 |
|  |  | <p>Intermediate block T including seals, mounting screws, and guiding pins. G1/4</p> | 0,17 | 9121658062 |
|  |  | <p>Intermediate block L including seals, mounting screws, and guiding pins. G1/4</p> | 0,17 | 9121658065 |
|  |  | <p>Blanking plate including seals, mounting screws.</p> | 0,05 | 9121658063 |

Dimensions

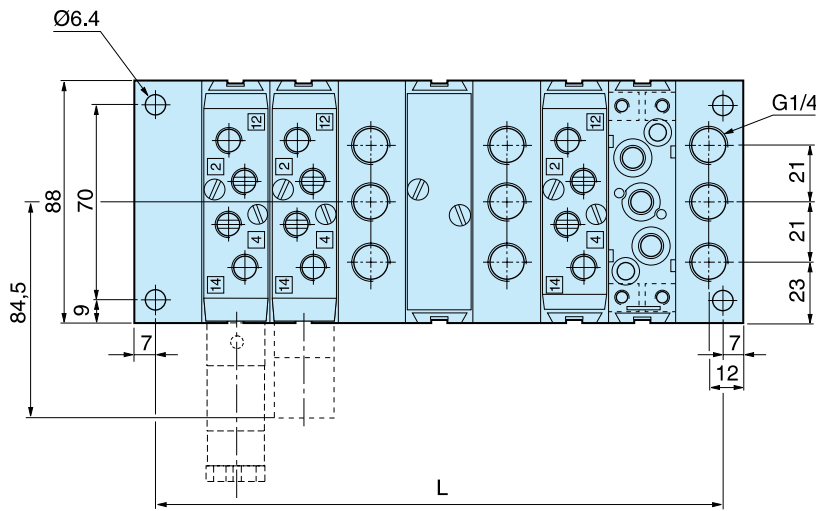

$$L = 34 + (\text{Number of manifolds and Intermediate blocks} \times 24)$$

Connection block L and intermediate blocks L and T can be turned so that connection can be made from above or below.
 Multiple manifolds must be fitted with the top indication line (a 10 mm long line) facing the same side on all manifolds.

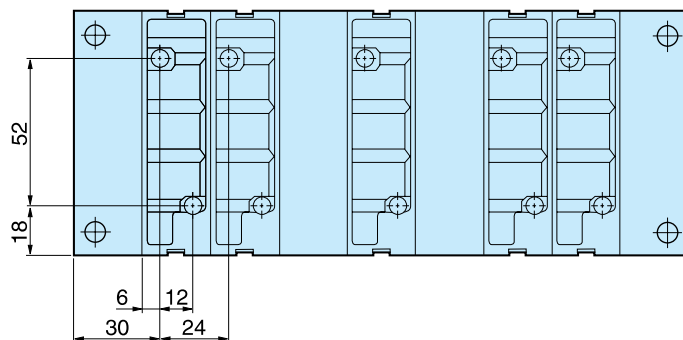
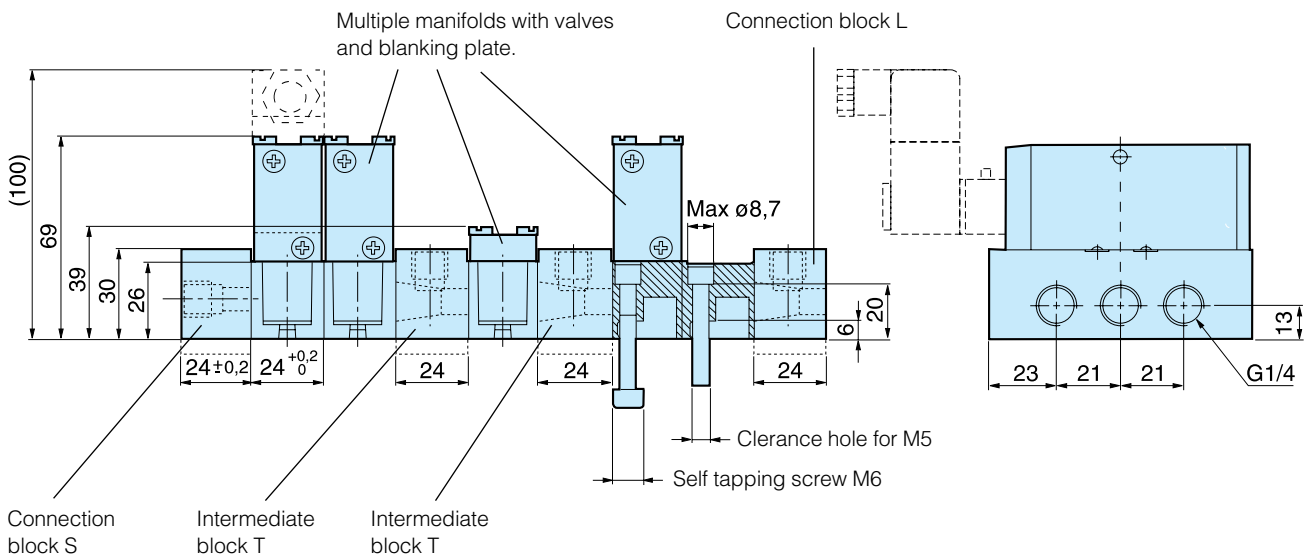

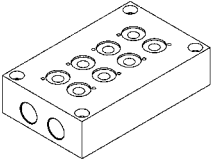
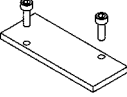
| Accessories | Type P2LA / P2LB 3/2 valves | Weight kg | Order code | |
|--|--|---|--|--------------------|
|  | Manifold bar, P2LA/P2LB (not for P2LB with external air supply to solenoid valves) incl. fasteners and O-ring. G3/8 For 2 valves For 4 valves For 6 valves For 8 valves For 10 valves | 0,69 1,13 1,56 2,00 2,45 | 91213202SXZ 91213204SXZ 91213206SXZ 91213208SXZ 91213210SXZ | |
| |  | Blanking plate for Manifold bar | 0,10 | 912132BPSXZ |

Dimensions



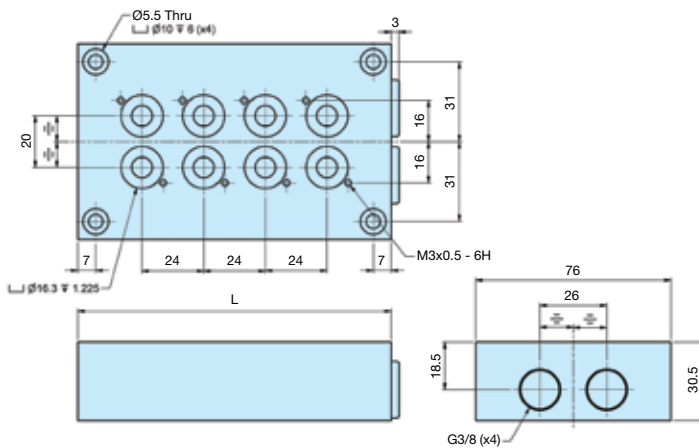



Manifold bar

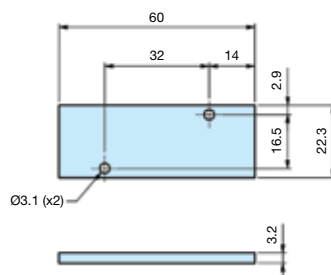

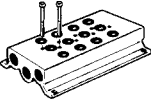
| No. of valves | L mm |
|---------------|------|
| 2 | 74 |
| 4 | 122 |
| 6 | 170 |
| 8 | 218 |
| 10 | 266 |

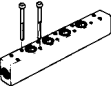
Blanking plate for manifold bar, P2LB



| Accessories P2LA | Type | Weight kg | Order code |
|---|--|--|--|
|  | Manifold bar, P2LA including seals, mounting screws. G3/8 For 4 valves For 6 valves For 8 valves For 10 valves For 12 valves For 14 valves | 0,48 0,63 0,80 0,98 1,10 1,23 | 9121658075 9121658076 9121658077 9121658078 9121658079 9121658099 |
|  | Blanking plate, P2LA for Manifold bar | 0,05 | 9121658063 |
|  | Pressure bar, P2LA for common air supply incl. O-rings and mounting screws. G1/4 For 2 valves For 4 valves For 6 valves For 8 valves | 0,13 0,20 0,26 0,33 | 9121658070 9121658071 9121658072 9121658073 |
|  | Blanking plate, P2LA for Pressure bar | 0,05 | 9121658074 |
|  | Assembly screws, P2LA in stainless steel for valve | 0,02 | 9121658043 |
|  | Assembly screws, P2LA in stainless steel for blanking plate | 0,01 | 9121658044 |
|  | O-ring kit, P2LA O-rings between valve and manifold bar/Pressure bar | 0,01 | 9121658046 |

Dimensions

Manifold bar, P2LA

| No. of valves | L mm |
|---------------|------|
| 4 | 126 |
| 6 | 174 |
| 8 | 222 |
| 10 | 270 |
| 12 | 318 |
| 14 | 366 |

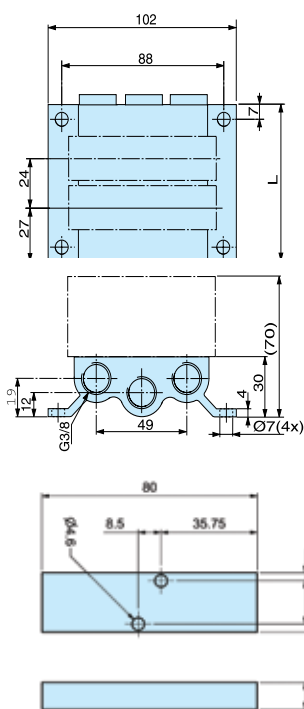

Blanking plate for manifold bar, P2LA

Pressure bar, P2LA

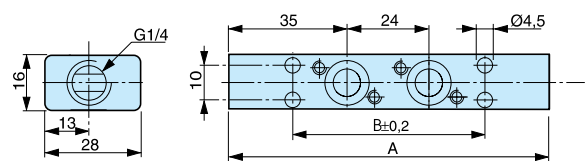

Blanking plate for pressure bar, P2LA

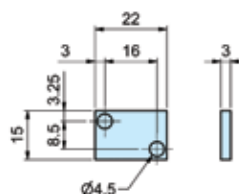

| No. of valves | A mm | B mm |
|---------------|------|------|
| 2 | 94 | 56 |
| 4 | 142 | 104 |
| 6 | 190 | 152 |
| 8 | 238 | 200 |

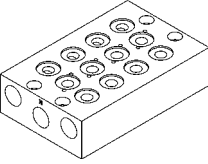
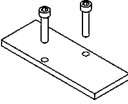
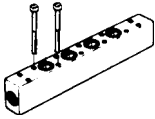
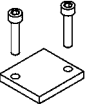
| Accessories P2LB | Type | Weight kg | Order code |
|---|--|--------------------------------------|--|
|  | Manifold bar, P2LB, (not for P2LB with external air supply to solenoid valves) incl. fasteners and O-ring. G3/8 For 2 valves For 4 valves For 6 valves For 8 valves For 10 valves | 0,69 1,13 1,56 2,00 2,45 | 9121594805X 9121594806X 9121594807X 9121594808X 9121594812X |
|  | Blanking plate, P2LBX for Manifold bar | 0,10 | 9121594809X |
|  | Pressure bar, P2LBX for common air supply incl. O-rings and mounting screws. G3/8 For 2 valves For 4 valves For 6 valves For 8 valves For 10 valves | 0,38 0,53 0,68 0,83 0,99 | 9127113301X 9127113302X 9127113303X 9127113304X 9127113305X |
|  | Blanking plate P2LBX for Pressure bar. G1/4 | 0,02 | 9127113306X |

Dimensions

Manifold bar, P2LB

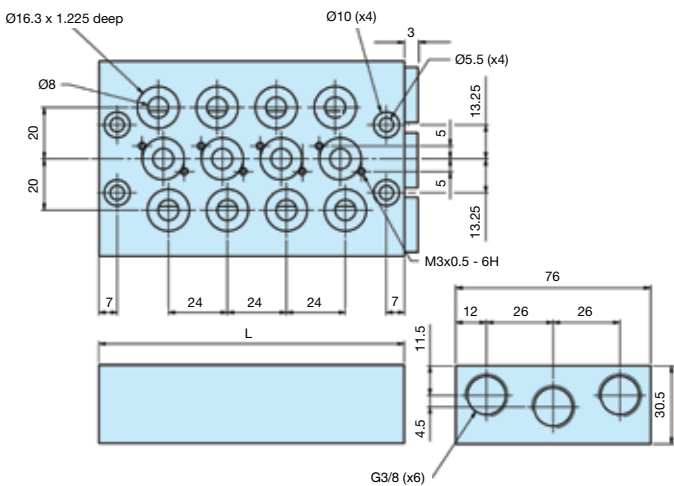

| No. of valves | L mm |
|---------------|------|
| 2 | 74 |
| 4 | 122 |
| 6 | 170 |
| 8 | 218 |
| 10 | 266 |

Blanking plate for manifold bar, P2LB

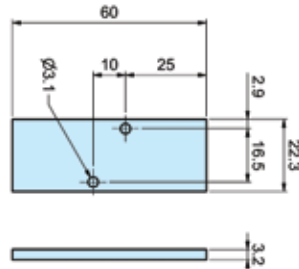

Pressure bar, P2LB

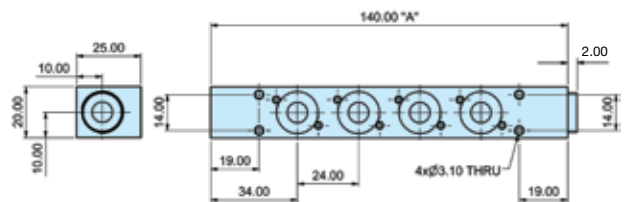

Blanking plate for pressure bar, P2LB

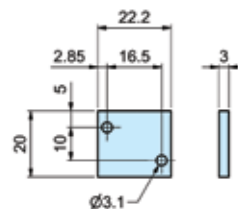

| No. of valves | A mm |
|---------------|------|
| 2 | 92 |
| 4 | 140 |
| 6 | 188 |
| 8 | 236 |
| 10 | 284 |

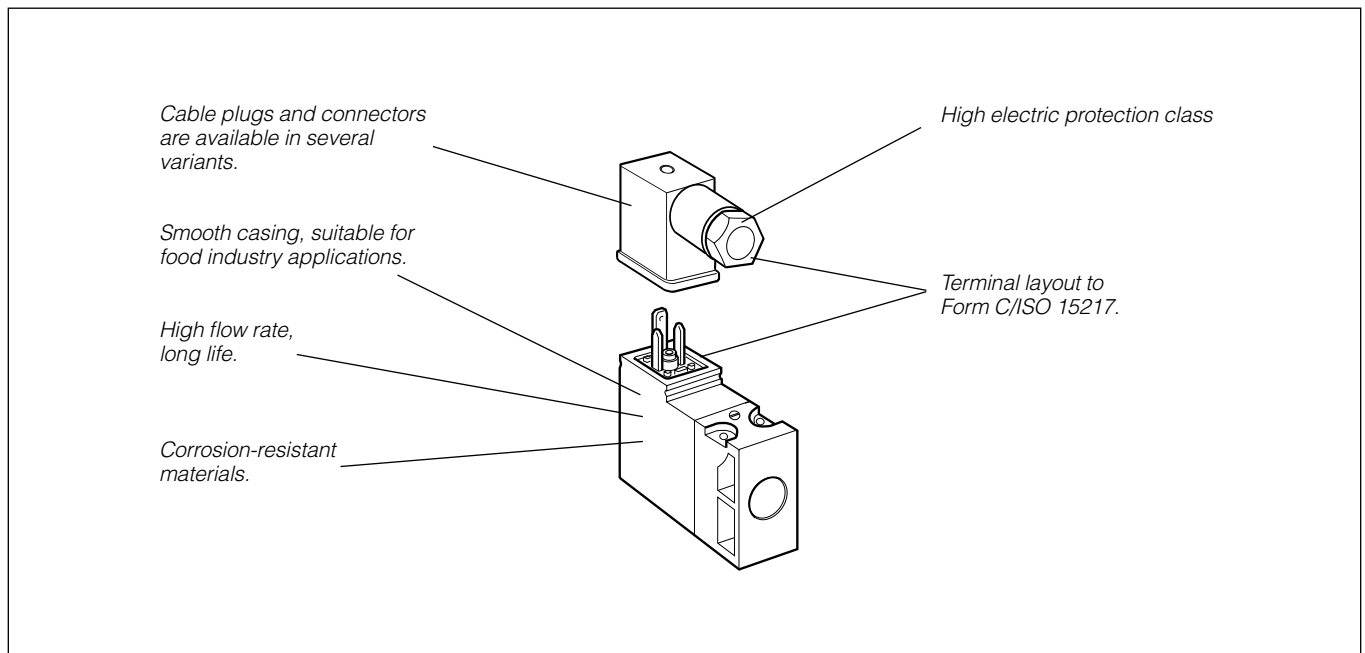

The P2E-•V solenoid operator range

The P2E-•V range of operators are normally closed (NC) 3/2 solenoid valves, with exceedingly compact dimensions in relation to their capacity.

International standard

The port connection pattern complies with a new French CNOMO standard (in process of drafting), with cable plug connections in accordance with Form C/ISO15217.

Compact design

Overall dimensions of the P2E-•V operators are substantially less than those of earlier generations of solenoid operators.

High flow capacity

High flow capacity relative to the electrical operating power as a result of optimised internal flow paths.

Corrosion-resistant design

The valve is made of thermoplastic material and stainless steel, with Viton™ and nitrile rubber seals for excellent corrosion resistance.

Clean lines suitable for food industry applications, P2E-QV

The valve has been designed in conjunction with several machine manufacturers and organisations in the food processing industry, with corrosion-resistant materials and smooth lines being important starting points. The valve and its accessories have been designed so that there are no gaps or crevices in which dirt could collect.

High reliability

Few moving parts result in high reliability, rapid changeover and very long life.

Low power demand

The solenoids have a power demand of 1.2 W at 24 V DC and 1.6 VA at 24 V AC, 115 V AC and 230 V AC.

High protection class

The protection class is IP 65 when connected using the cable plug with a moulded cable. When using the standard cable plug for fitting by the user, the protection class is IP65, the bare valve, with Fast-on connectors, has an encapsulation class of IP 20.

Insensitive to dirty air

The use of generously sized flow paths (1.0 mm diameter) means that the valve can be used in normal industrial environments without problems of blocking.

Manual override as option

The operators can be supplied with our without manual override. The manual override device is available as a screwdriver groove or with a control arm, and is either spring return (blue) or lockable (yellow).

Order key, solenoid operators (15mm)

| | | | | | | | | | | |
|--|----------|----------|----------|----------|----------|--|----------|---|----------|--|
| P | 2 | E | - | Q | V | 3 | 2 | C | 3 | |
| Valve family | | | | | | Type of current | | Voltage | | Overrides |
| P2E Solenoid operator | | | | | | 1 AC 50 Hz 2 DC 4 AC 50/60 Hz 5 Mobile and wide band only | | B 12 V C 24 V D 48 V F 115 V* J 230 V* W 37,5 V** T 72 V** Y 78 V** V 96 V** E 110 V** | | 0 Without 1 Non locking (blue) 2 Locking (yellow) 3 Extended non locking (blue) 4 Extended locking (yellow) |
| Subfamily | | | | | | Valvetype/Function | | | | |
| Solenoid operator, 15 mm wide Electric connection acc. to ISO 15217 Form C EI/supply connection on opposite side | | | | | | 3  3/2 valve, normally closed (NC) | | | | |
| K Standard version | | | | | | | | | | |
| M Mobile version | | | | | | | | | | |
| Q Food industry version | | | | | | | | | | |

* For standard and food type only
** For mobile "M" version only

Technical data

| | NC, Standard | NC, Food ¹⁾ | NC, Mobile ²⁾ |
|-----------------------|--|------------------------|--------------------------|
| Working pressure | 0 to 10 bar | 0 to 10 bar | 0 to 10 bar |
| Working temperature | -15 °C to +60 °C | -15 °C to +60 °C | -40 °C to +70 °C |
| Orifice | 1,0 mm | 1,0 mm | 1,0 mm |
| Flow Q _{max} | 33 Nl/min | 33 Nl/min | 22 Nl/min |
| Power, hold | DC 1,2 W / AC 1,6 VA * | DC 1,2 W / AC 1,6 VA * | DC 1,4 W |
| Power, surge | DC 1,2 W / AC 3,5 VA * | DC 1,2 W / AC 3,5 VA * | DC 1,4 W |
| Connection time | 100% | 100% | 100% |
| Voltage tolerance | +10%/-15% | +10%/-15% | +25%/-30% |
| Electric connection: | Form C/ISO15217 | | |
| Port pattern: | To future CNOMO standard | | |
| Protection: | IP 65 | | |
| Approval: | Some valves are UL 429 recognised and marked with the following symbol  | | |
| Working media: | All neutral media, such as compressed air, water, hydraulic oil and many gases. | | |
| 1) Design: | Completely smooth exterior, suitable for food industry. | | |
| 2) Mobile standard | According to European standard EN 50 155. | | |

* Power, hold for 230VAC 2.4VA
Power, surge for 230VAC 5.5VA

Transients

Interrupting the current through the solenoid coil produces momentary voltage peaks which, under unfavourable conditions, can amount to several hundred times the rated operating voltage. Normally, these transients do not cause problems, but to achieve the maximum life of relays in the circuit (and particularly of transistors, thyristors and integrated circuits) it is desirable to provide protection by means of voltage-dependent resistors (varistors). All cable plugs with a yellow LED also incorporate such protection.

Service life

With compressed air at 6 bar, 20 °C and complying with the requirements for compressed air quality as set out in ISO8573-1 norm (class 4 for dry and class 5 for filtered air), the valves should have a life of at least 50 million cycles.

Materials

Operator

| | |
|----------------------|---------------------------------|
| Body, coil casing | Thermoplastic |
| Internal metal parts | Steel |
| Screws | Stainless steel |
| Bottom plug | Thermoplastic |
| Sealing materials | FPM (Viton™) and nitrile rubber |

Cable head

| | |
|-----------------|------------------------------------|
| Sheath | Thermoplastic |
| Retaining screw | Stainless steel, zinc-plated steel |

15mm Solenoid Operators

Electrical connection EN175301-803 C/ISO15217 (Ex DIN 43650C)

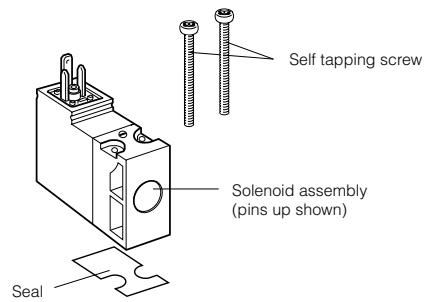

Solenoids 15 mm NC, standard

| | Voltage | Weight Kg | Order code Without manual override | Weight Kg | Order code Override, blue, non locking flush | Weight Kg | Order code Override, yellow, locking flush |
|--|-------------------------------|--------------|--|---------------------|--|---------------------|--|
| | 12 VDC | 0,038 | P2E-KV32B0 | 0,038 | P2E-KV32B1 | 0,038 | P2E-KV32B2 |
| | 24 VDC | 0,038 | P2E-KV32C0 | 0,038 | P2E-KV32C1 | 0,038 | P2E-KV32C2 |
| | 48 VDC | 0,038 | P2E-KV32D0 | 0,038 | P2E-KV32D1 | 0,038 | P2E-KV32D2 |
| | 24 VAC 50Hz | 0,038 | P2E-KV31C0 | 0,038 | P2E-KV31C1 | 0,038 | P2E-KV31C2 |
| | 48 VAC 50/60Hz | 0,038 | P2E-KV34D0 | 0,038 | P2E-KV34D1 | 0,038 | P2E-KV34D2 |
| | 115 VAC 50Hz/ 120 VAC 60Hz | 0,038 | P2E-KV31F0 | 0,038 | P2E-KV31F1 | 0,038 | P2E-KV31F2 |
| | 230 VAC 50Hz/ 240 VAC 60Hz | 0,038 | P2E-KV31J0 | 0,038 | P2E-KV31J1 | 0,038 | P2E-KV31J2 |
| | | | | | | | |
| | Voltage | | | Weight Kg | Order code Override extended, non locking flush | Weight Kg | Order code Override extended, locking flush |
| | 24 VDC | | | 0,038 | P2E-KV32C3 | 0,038 | P2E-KV32C4 |
| | 24 VAC 50Hz | | | 0,038 | P2E-KV31C3 | 0,038 | P2E-KV31C4 |

Solenoids 15 mm NC, mobile

(Note! Mounting screws included in basic valve)

| | Voltage | Weight Kg | Order code Without manual override | Weight Kg | Order code Override, blue, non locking flush |
|--|----------|--------------|--|--------------|--|
| | 12 VDC | 0,038 | P2E-MV35B0 | 0,038 | P2E-MV35B1 |
| | 24 VDC | 0,038 | P2E-MV35C0 | 0,038 | P2E-MV35C1 |
| | 37,5 VDC | 0,038 | P2E-MV35W0 | 0,038 | P2E-MV35W1 |
| | 48 VDC | 0,038 | P2E-MV35D0 | 0,038 | P2E-MV35D1 |
| | 72 VDC | 0,038 | P2E-MV35T0 | 0,038 | P2E-MV35T1 |
| | 78 VDC | 0,038 | P2E-MV35Y0 | 0,038 | P2E-MV35Y1 |
| | 96 VDC | 0,038 | P2E-MV35V0 | 0,038 | P2E-MV35V1 |
| | 110 VDC | 0,038 | P2E-MV35E0 | 0,038 | P2E-MV35E1 |

Solenoids 15 mm NC, food industry version

(Note! Mounting screws included in basic valve)

| | Voltage | Weight Kg | Order code Without manual override | Weight Kg | Order code Override, blue, non locking flush | Weight Kg | Order code Override, yellow, locking flush |
|--|-------------------------------|--------------|--|---------------------|--|---------------------|--|
| | 24 VDC | 0,038 | P2E-QV32C0 | 0,038 | P2E-QV32C1 | 0,038 | P2E-QV32C2 |
| | 48 VDC | 0,038 | P2E-QV32D0 | 0,038 | P2E-QV32D1 | 0,038 | P2E-QV32D2 |
| | 24 VAC 50Hz | 0,038 | P2E-QV31C0 | 0,038 | P2E-QV31C1 | 0,038 | P2E-QV31C2 |
| | 48 VAC 50/60Hz | 0,038 | P2E-QV34D0 | 0,038 | P2E-QV34D1 | 0,038 | P2E-QV34D2 |
| | 115 V 50Hz/ 120 V 60Hz | 0,038 | P2E-QV31F0 | 0,038 | P2E-QV31F1 | 0,038 | P2E-QV31F2 |
| | 230 VAC 50Hz/ 240 VAC 60Hz | 0,038 | P2E-QV31J0 | 0,038 | P2E-QV31J1 | 0,038 | P2E-QV31J2 |
| | | | | | | | |
| | | | | | | | |
| | Voltage | | | Weight Kg | Order code Override extended, non locking flush | Weight Kg | Order code Override extended, locking flush |
| | 24 VDC | | | 0,038 | P2E-QV32C3 | 0,038 | P2E-QV32C4 |
| | 24 VAC 50Hz | | | 0,038 | P2E-QV31C3 | 0,038 | P2E-QV31C4 |
| | 115 VAC 50 Hz | | | 0,038 | P2E-QV31F3 | 0,038 | P2E-QV31F4 |
| | 230 VAC 50 Hz | | | 0,038 | P2E-QV31J3 | 0,038 | P2E-QV31J4 |

In accordance with the EU Machine Directive, EN 983, solenoid valves with manual override should have spring-return operating arms for safety.

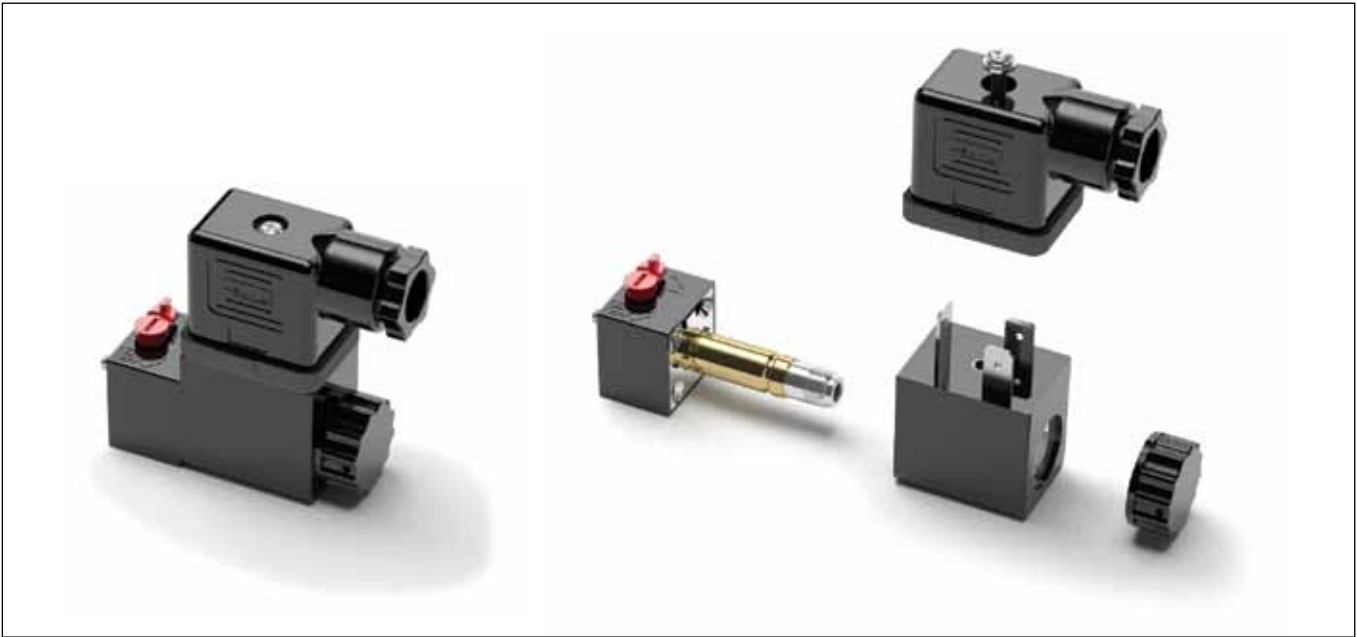

22mm Solenoid pilot options

The P2F P13*4* (NC) 3/2 solenoid pilot operators are designed for piloting pneumatic control valves with compressed air or other inert gases.

The P2F P operator is available for Normal operating pressures up to 10 bar having an outlet orifice 1.3mm and exhaust orifice 1.5 mm. An alternative operator is also available having an outlet orifice of 0.8mm and exhaust orifice of 1.0mm for Xtreme maximum operating pressure of 16 bar and wide band voltage tolerances required for mobile applications.

For hard environment, a metal operator (anodised aluminium) with brass manual override is available with a 1.2 mm outlet orifice and 1.3mm exhaust orifice. Different temperature range is covering inside, outside application.

Corrosion resistant design

The pilot operator body is manufactured in thermoplastic PA 6 material and the core tube brass/stainless steel. The plunger/core is made from stainless steel and the valve seats from FKM.

Mobile Applications

Viking Xtreme valves are tested to +5g shock and vibration. Solenoid operated valves are designed to operate with wide voltage tolerance bands within the ambient temperature ranges stated in the technical section.

Solenoid Pilot Exhaust

These operators all exhaust out of the top of the core tube which is tapped M5. The standard solenoid nut fitted to the core tube is the Diffuser nut which allows the exhaust to escape to atmosphere. This nut also minimises ingress of dirt into the valve through this port. The alternative plastic knurled nut can be specified (refer to part number system) if the exhaust air needs to be captured and piped away using the M5 tapped port.

Manual Override options

The pilot operators can be supplied with or without manual override. The standard manual override is the monostable (spring return) extended brass override. Alternatively the bistable (locking) override can be specified as an alternative for the Normal duty 10bar option.

Coils

Coils are wound with enameled copper wire, having temperature index 180°C with class F insulation (155°C) and are encapsulated in Thermoplastic resin. When fitted with suitable connector and correct gasket they give protection to IP65.

Spares

Solenoid operators are available as spares complete with mounting screws and seals. Coils and connectors should be ordered separately.

Order key, solenoid operators (22mm)

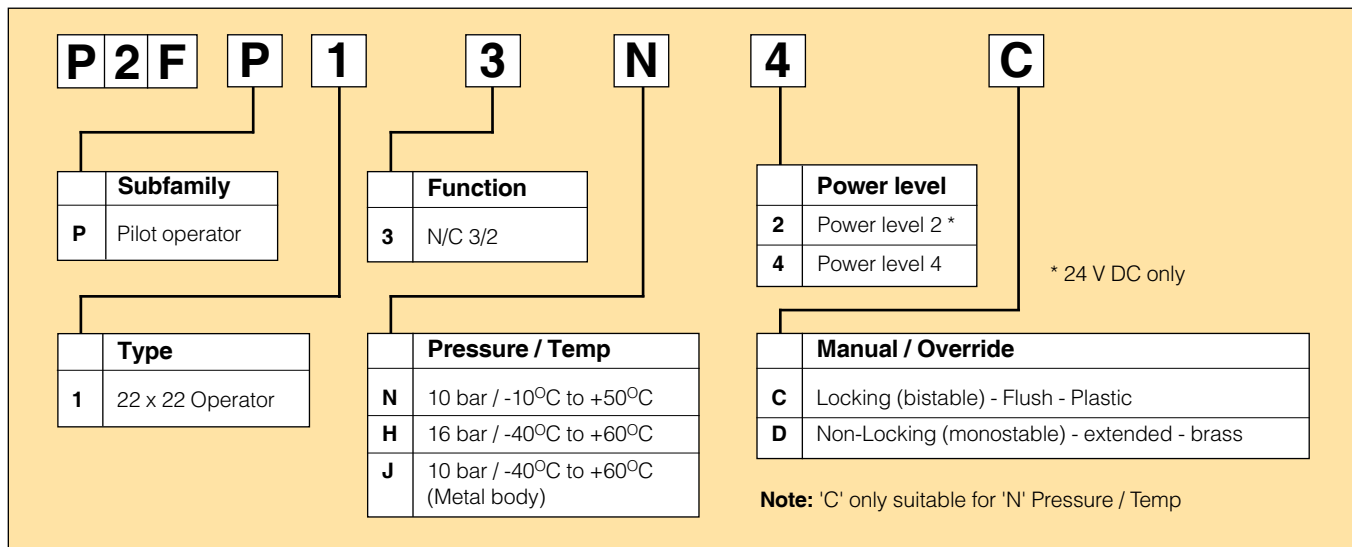

Technical data

| | NC Normal | NC Xtreme | NC 22mm Xtreme (Mobile) | NC 30mm Xtreme (Mobile) | NC 30 mm Metal (Mobile) |
|------------------------------|---|------------------|-------------------------|-------------------------|-------------------------|
| Working pressure | 0 to 10 bar | 0 to 16 bar | 0 to 10 bar | 0 to 16 bar | 0 to 10 bar |
| Ambient temperature | -10 °C to +50 °C | -40 °C to +60 °C | -40 °C to +60 °C | -40 °C to +60 °C | -40 °C to +60 °C |
| Orifice | 1.3/1.5mm | 0.8/1.0mm | 0.8/1.0mm | 0.8/1.0mm | 1,2 mm / 1,3mm |
| Flow Qn @ 6 bar input | | | | | |
| 1 bar press drop. 1-2 l/m | 55 | 20 | 20 | 20 | 60 |
| Flow Qn @ 6 bar input | | | | | |
| 1 bar press drop. 2-3 l/m | 70 | 30 | 30 | 30 | 70 |
| Power (DC) | 4.8W (2W Low power) | 4.8W | 6.0W | 6.8W | 6.8W |
| Power (AC) | 8.5VA | 8.5VA | | | |
| Voltage tolerance (Standard) | +/- 10% | +/- 10% | | | |
| Voltage tolerance (Mobile) | | | -10 to +30% | +/- 30% | +/- 30% |
| Duty cycle | 100% | 100% | 100% | 100% | 100% |
| Insulation class | F | F | F | F | F |
| Electric connection | Ind Form B | Ind Form B | Ind Form B | Form A | Form A |
| Protection | IP65 | IP65 | IP65 | IP65 | IP65 |
| Shock & Vibration | - | 0 to +5g | 0 to +5g | 0 to +5g | 0 to 5g |
| Approval | UL coil version available on request | | | | |
| Working media | All neutral media such as compressed air and inert gases. | | | | |

Mobile applications

Solenoid operated Viking Xtreme duty valves for Mobile applications are fitted with the P2FP13H4D solenoid pilot operator. It has a 22mm footprint with 0.8/1.0mm orifice and will accept 22mm or 30mm coil options. The choice of coil option will depend on the voltage tolerance, operating ambient temperature range and maximum operating pressure. Use the technical data in the table above before selecting the coil type required, or contact our technical department.

Transients

Interrupting the current through the solenoid coil produces momentary voltage peaks which, under unfavourable conditions, can amount to several hundred times the rated operating voltage. Normally, these transients do not cause problems, but to achieve the maximum life of relays in the circuit (and particularly of transistors, thyristors and integrated circuits) it is desirable to provide protection by means of voltage-dependent resistors (varistors). All connectors/ cable plugs with LED's listed on page 54 include this type of circuit protection.

Materials

Pilot Valve

| | |
|-----------------|--|
| Body: | Polyamide |
| Body: | Anodised aluminium for J type |
| Armature tube: | Brass (Normal) Stainless Steel 16 bar mobile |
| Plunger & core: | Corrosion resistant Cr-Ni steel |
| Seals: | FKM (Viton™) |
| Screws: | Stainless steel |

Coil

| | |
|-------------------------|---------------|
| Encapsulation material: | Thermoplastic |
|-------------------------|---------------|

22mm solenoid operator part numbers and spares

Solenoids coil standard 22mm

| Voltage | Voltage tolerance | Temperature | Order code Form B | Power | Weight (Kg) | Use with Operator type |
|----------------------|-------------------|--------------|-------------------|-------|-------------|------------------------|
| 12V 50Hz | +/-10% | -10°C / 50°C | P2FCB440 | 8,5VA | 0.053 | P2FP13N4 |
| 24V 50/60Hz | +/-10% | -10°C / 50°C | P2FCB442 | 8,5VA | 0.053 | P2FP13N4 |
| 48V 50/60Hz | +/-10% | -10°C / 50°C | P2FCB449 | 8,5VA | 0.053 | P2FP13N4 |
| 120V/50Hz, 120V/60Hz | +/-10% | -10°C / 50°C | P2FCB453 | 8,5VA | 0.053 | P2FP13N4 |
| 230V/50Hz, 230V/60Hz | +/-10% | -10°C / 50°C | P2FCB457 | 8,5VA | 0.053 | P2FP13N4 |
| 12V DC | +/-10% | -10°C / 50°C | P2FCB445 | 4,8W | 0.053 | P2FP13N4 |
| 24V DC | +/-10% | -10°C / 50°C | P2FCB449 | 4,8W | 0.053 | P2FP13N4 |
| 48V DC | +/-10% | -10°C / 50°C | P2FCB451 | 4,8W | 0.053 | P2FP13N4 |

For pressure 0 to 10 bar

Solenoids coil low power 22mm

| Voltage | Order code Form B | Power | Weight (Kg) | Use with Operator type |
|------------------|-------------------|-------|-------------|------------------------|
| 24V DC Low power | P2FCB249 | 2W | 0.093 | P2FP13N2 |

For pressure 0 to 10 bar

Solenoids coil 22mm Xtreme

| Voltage | Voltage tolerance | Temperature | Order code Form B | Power | Weight (Kg) | Use with Operator type |
|----------------------|-------------------|--------------|-------------------|-------|-------------|------------------------|
| 12V 50Hz | +/-10% | -40°C / 60°C | P2FCB440 | 8,5VA | 0.053 | P2FP13NH4D |
| 24V 50/60Hz | +/-10% | -40°C / 60°C | P2FCB442 | 8,5VA | 0.053 | P2FP13NH4D |
| 48V 50/60Hz | +/-10% | -40°C / 60°C | P2FCB449 | 8,5VA | 0.053 | P2FP13NH4D |
| 120V/50Hz, 120V/60Hz | +/-10% | -40°C / 60°C | P2FCB453 | 8,5VA | 0.053 | P2FP13NH4D |
| 230V/50Hz, 230V/60Hz | +/-10% | -40°C / 60°C | P2FCB457 | 8,5VA | 0.053 | P2FP13NH4D |
| 12V DC | +/-10% | -40°C / 60°C | P2FCB445 | 4,8W | 0.053 | P2FP13NH4D |
| 24V DC | +/-10% | -40°C / 60°C | P2FCB449 | 4,8W | 0.053 | P2FP13NH4D |
| 48V DC | +/-10% | -40°C / 60°C | P2FCB451 | 4,8W | 0.053 | P2FP13NH4D |

For pressure 0 to 16 bar for A+B & 12 bar for C+D

Solenoids coil mobile voltage 22mm

| Voltage | Voltage tolerance | Temperature | Order code Form B | Power | Weight (Kg) | Use with Operator type |
|---------|-------------------|---------------|-------------------|-------|-------------|------------------------|
| 12V DC | -10% / +30% | -40°C / +60°C | P2FCB447 | 6W | 0.053 | P2FP13H4D |
| 24V DC | -10% / +30% | -40°C / +60°C | P2FCB448 | 6W | 0.053 | P2FP13H4D |

For pressure 0 to 16 bar for A+B & 12 bar for C+D

Solenoids coil Mobile voltage 30mm

| Voltage | Voltage tolerance | Temperature | Order code Form A | Power | Weight (Kg) | Use with Operator type |
|---------|-------------------|---------------|-------------------|-------|-------------|------------------------|
| 12V DC | +/- 30% | -40°C / +60°C | P2FCA447 | 6,8W | 0.09 | P2FP13H4D |
| 24V DC | +/- 30% | -40°C / +60°C | P2FCA448 | 6,8W | 0.09 | P2FP13H4D |
| 48V DC | +/- 30% | -40°C / +60°C | P2FCA474 | 6,8W | 0.09 | P2FP13H4D |
| 72V DC | +/- 30% | -40°C / +60°C | P2FCA470 | 6,8W | 0.09 | P2FP13H4D |
| 96V DC | +/- 30% | -40°C / +60°C | P2FCA471 | 6,8W | 0.09 | P2FP13H4D |
| 110V DC | +/- 30% | -40°C / +60°C | P2FCA472 | 6,8W | 0.09 | P2FP13H4D |

For pressure 0 to 16 bar for A+B & 12 bar for C+D

Solenoids coil Mobile voltage 30mm

| Voltage | Voltage tolerance | Temperature | Order code Form A | Power | Weight (Kg) | Use with Operator type |
|---------|-------------------|---------------|-------------------|-------|-------------|------------------------|
| 12V DC | +/- 30% | -40°C / +60°C | P2FCA447 | 6,8W | 0.09 | P2FP13J4 |
| 24V DC | +/- 30% | -40°C / +60°C | P2FCA448 | 6,8W | 0.09 | P2FP13J4 |
| 48V DC | +/- 30% | -40°C / +60°C | P2FCA474 | 6,8W | 0.09 | P2FP13J4 |
| 72V DC | +/- 30% | -40°C / +60°C | P2FCA470 | 6,8W | 0.09 | P2FP13J4 |
| 96V DC | +/- 30% | -40°C / +60°C | P2FCA471 | 6,8W | 0.09 | P2FP13J4 |
| 110V DC | +/- 30% | -40°C / +60°C | P2FCA472 | 6,8W | 0.09 | P2FP13J4 |

For pressure 0 to 10 bar

Spare Solenoid Nuts

Valves requiring captured exhaust should be fitted with plastic knurled nut

| Order code |
|--------------|
| P2FNP |

Valves with vented exhaust are fitted with diffuser plastic nut

| Order Code |
|--------------|
| P2FND |

Spare Solenoid Operators

Solenoid pilot operator 22mm NC, Normal duty (Max Operating pressure 10bar, Temp -10°C to +50°C)

| Order code (with locking bi-stable m/o) | weight Kg | Order code (with Non-locking monostable m/o) | weight Kg |
|---|--------------|--|--------------|
| P2FP13N4C | 0.05kg | P2FP13N4D | 0.05kg |

Low power pilot operator NC, Normal duty (Max Operating pressure 10bar, Temp -10°C to +50°C)

| Order code (with locking bi-stable m/o) | weight Kg | Order code (with Non-locking monostable m/o) | weight Kg |
|---|--------------|--|--------------|
| P2FP13N2C | 0.05kg | P2FP13N2D | 0.05kg |

Solenoid pilot operator 22mm NC, Xtreme duty (Max Operating pressure 16bar, Temp -40°C to +60°C)

| Order code (with Non-locking monostable m/o) | weight Kg |
|--|--------------|
| P2FP13H4D | 0.05kg |

Solenoid pilot operator 22mm NC Mobile metal (Max Operating pressure 10bar, Temp -40°C to +60°C)



| Order code (with brass non locking m/o) | weight Kg | Order code (with brass locking m/o) | weight Kg | Order code No manual override | weight Kg |
|---|--------------|---|--------------|-------------------------------------|--------------|
| P2FP13J4B | 0.04kg | P2FP13J4C | 0.04kg | P2FP13J4A | 0.04kg |

Note.

Solenoid pilot operators are fitted to the Viking valve range. Order the above part numbers for spares. The operators are supplied with mounting screws and interface 'O' rings.

Coils and connectors must be ordered separately.

Solenoid Connectors / Cable Plugs EN175301-803

| | Description | Order code 15mm Form C/ISO15217 | Order code 22mm Industrial Form B | Order code 30mm Form A/ISO4400 |
|---|---|--|--|---|
| With large headed screw suitable for mounting in inaccessible or recess position  | Standard IP65 | P8C-C | | |
| | 24V DC LED and protection IP65 | P8C-C26C | | |
| | 110V AC LED and protection IP65 | P8C-C21E | | |
| With standard screw  | Standard IP65 without flying lead | P8C-D | 3EV10V10 | 3EV290V10 |
| | With LED and protection 24V AC/DC | P8C-D26C | 3EV10V20-24 | 3EV290V20-24 |
| | With LED and protection 110V AC/DC | P8C-D21E | 3EV10V20-110 | |
| | With LED and protection 230V AC | | 3EV10V20-230 | |
| With cable  | Standard with 2m cable IP65 | P8L-C2 | | |
| | Standard with 5m cable IP65 | P8L-C5 | | |
| | 24V AC/DC, 2m cable LED and protection IP65 | P8L-C226C | | |
| | 24V AC/DC, 5m cable LED and protection IP65 | P8L-C526C | 3EV10V20-24L5 | 3EV290V20-24L5 |
| | 24V AC/DC, 10m cable LED and protection IP65 | P8L-CA26C | | |
| | 110V AC/DC, 2m cable LED and protection IP65 | P8L-C221E | | |
| | 110V AC/DC, 5m cable LED and protection IP65 | P8L-C521E | 3EV10V20-110L5 | |
| 230V AC, 5m cable LED and protection IP65 | | 3EV10V20-230L5 | | |

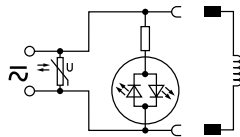
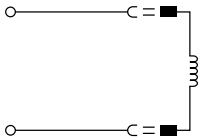

| | | |
|------------------|---------------------|-----------------------|
| P8C-C | P8C-D26C | P8L-C226C |
| P8C-D | P8C-D21E | P8L-C526C |
| P8L-C2 | P8C-C26C | P8L-CA26C |
| P8L-C5 | P8C-C21E | P8L-C221E |
| 3EV10V10 | | P8L-C521E |
| 3EV290V10 | 3EV10V20-24 | 3EV10V20-24L5 |
| | 3EV10V20-110 | 3EV10V20-110L5 |
| | 3EV10V20-230 | 3EV10V20-230L5 |

Cable Plug Dimensions (mm)

Solenoid operators P2E-•V...

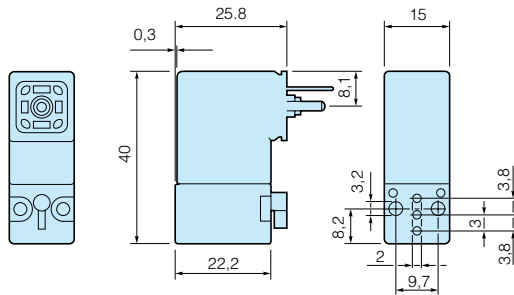

Solenoid operators P2FP...

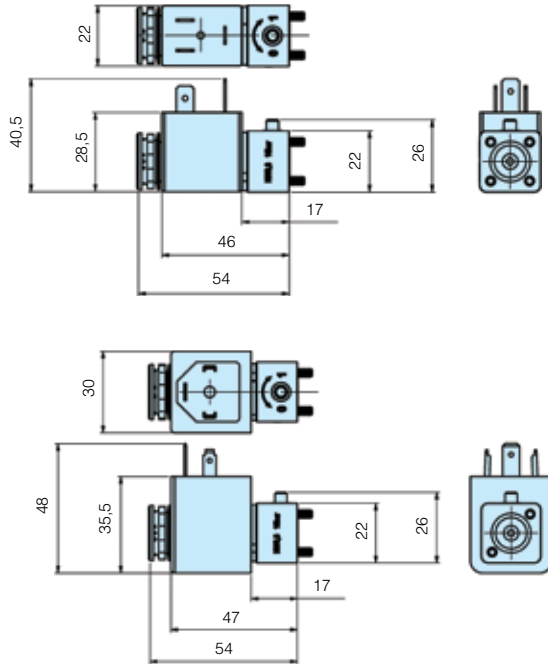

Cable plugs

- P8C-C
- P8C-C26C
- P8C-C21E
- P8C-D
- P8C-D26C
- P8C-D21E

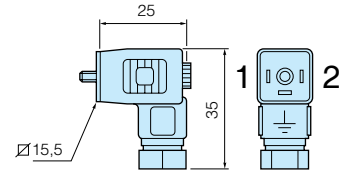

Cable plugs with cables

- P8L-C2
- P8LC5
- P8L-C226C
- P8L-C526C
- P8L-CA26C
- P8L-C221E
- P8L-C521E

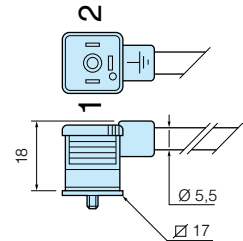

Cable plugs Form B

- 3EV10V10
- 3EV10V20-24
- 3EV10V20-110
- 3EV10V20-230
- 3EV10V20-24L5
- 3EV10V20-110L5
- 3EV10V20-230L5

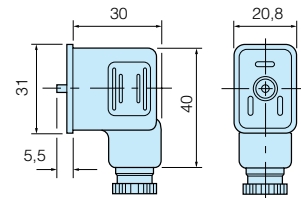

Cable plugs Form A

- 3EV290V10
- 3EV290V20-24
- 3EV290V20-24L5

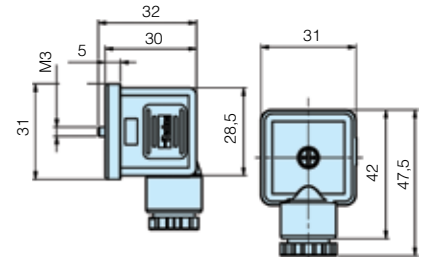

Accessories

Sintered bronze series

| Port | Order code | Pack Qty |
|------|------------|----------|
| M5 | 9721900005 | 1 |
| G1/8 | 9090050700 | 1 |
| G1/4 | P6M-BAA2 | 1 |
| G3/8 | 9090050900 | 1 |
| G1/2 | 9090051000 | 1 |

Male straight connectors - Parallel thread

| Tube Ø1 | Thread B | Order code | Box Qty |
|---------|----------|------------|---------|
| 4 | 1/8 | F4PMB4-1/8 | 20 |
| 6 | 1/8 | F4PMB6-1/8 | 30 |
| 6 | 1/4 | F4PMB6-1/4 | 30 |
| 8 | 1/8 | F4PB8-1/8 | 40 |
| 8 | 1/4 | F4PB8-1/4 | 30 |
| 8 | 3/8 | F4PB8-3/8 | 20 |
| 10 | 1/4 | F4PB10-1/4 | 20 |
| 10 | 3/8 | F4PB10-3/8 | 20 |
| 10 | 1/2 | F4PB10-1/2 | 10 |
| 12 | 1/4 | F4PB12-1/4 | 10 |
| 12 | 3/8 | F4PB12-3/8 | 10 |
| 12 | 1/2 | F4PB12-1/2 | 10 |
| 14 | 3/8 | F4PB14-3/8 | 10 |
| 14 | 1/2 | F4PB14-1/2 | 10 |

Parker Worldwide

Europe, Middle East, Africa

AE – United Arab Emirates,
Dubai

Tel: +971 4 8127100
parker.me@parker.com

AT – Austria, Wiener Neustadt

Tel: +43 (0)2622 23501-0
parker.austria@parker.com

AT – Eastern Europe, Wiener
Neustadt

Tel: +43 (0)2622 23501 900
parker.easteurope@parker.com

AZ – Azerbaijan, Baku

Tel: +994 50 2233 458
parker.azerbaijan@parker.com

BE/LU – Belgium, Nivelles

Tel: +32 (0)67 280 900
parker.belgium@parker.com

BY – Belarus, Minsk

Tel: +375 17 209 9399
parker.belarus@parker.com

CH – Switzerland, Etoy

Tel: +41 (0)21 821 87 00
parker.switzerland@parker.com

CZ – Czech Republic, Klecany

Tel: +420 284 083 111
parker.czechrepublic@parker.com

DE – Germany, Kaarst

Tel: +49 (0)2131 4016 0
parker.germany@parker.com

DK – Denmark, Ballerup

Tel: +45 43 56 04 00
parker.denmark@parker.com

ES – Spain, Madrid

Tel: +34 902 330 001
parker.spain@parker.com

FI – Finland, Vantaa

Tel: +358 (0)20 753 2500
parker.finland@parker.com

FR – France, Contamine s/Arve

Tel: +33 (0)4 50 25 80 25
parker.france@parker.com

GR – Greece, Athens

Tel: +30 210 933 6450
parker.greece@parker.com

HU – Hungary, Budapest

Tel: +36 23 885 475
parker.hungary@parker.com

IE – Ireland, Dublin

Tel: +353 (0)1 466 6370
parker.ireland@parker.com

IT – Italy, Corsico (MI)

Tel: +39 02 45 19 21
parker.italy@parker.com

KZ – Kazakhstan, Almaty

Tel: +7 7272 505 800
parker.easteurope@parker.com

NL – The Netherlands, Oldenzaal

Tel: +31 (0)541 585 000
parker.nl@parker.com

NO – Norway, Asker

Tel: +47 66 75 34 00
parker.norway@parker.com

PL – Poland, Warsaw

Tel: +48 (0)22 573 24 00
parker.poland@parker.com

PT – Portugal, Leca da Palmeira

Tel: +351 22 999 7360
parker.portugal@parker.com

RO – Romania, Bucharest

Tel: +40 21 252 1382
parker.romania@parker.com

RU – Russia, Moscow

Tel: +7 495 645-2156
parker.russia@parker.com

SE – Sweden, Spånga

Tel: +46 (0)8 59 79 50 00
parker.sweden@parker.com

SK – Slovakia, Banská Bystrica

Tel: +421 484 162 252
parker.slovakia@parker.com

SL – Slovenia, Novo Mesto

Tel: +386 7 337 6650
parker.slovenia@parker.com

TR – Turkey, Istanbul

Tel: +90 216 4997081
parker.turkey@parker.com

UA – Ukraine, Kiev

Tel: +380 44 494 2731
parker.ukraine@parker.com

UK – United Kingdom, Warwick

Tel: +44 (0)1926 317 878
parker.uk@parker.com

ZA – South Africa, Kempton Park

Tel: +27 (0)11 961 0700
parker.southafrica@parker.com

North America

CA – Canada, Milton, Ontario

Tel: +1 905 693 3000

US – USA, Cleveland

Tel: +1 216 896 3000

Asia Pacific

AU – Australia, Castle Hill

Tel: +61 (0)2-9634 7777

CN – China, Shanghai

Tel: +86 21 2899 5000

HK – Hong Kong

Tel: +852 2428 8008

IN – India, Mumbai

Tel: +91 22 6513 7081-85

JP – Japan, Tokyo

Tel: +81 (0)3 6408 3901

KR – South Korea, Seoul

Tel: +82 2 559 0400

MY – Malaysia, Shah Alam

Tel: +60 3 7849 0800

NZ – New Zealand, Mt Wellington

Tel: +64 9 574 1744

SG – Singapore

Tel: +65 6887 6300

TH – Thailand, Bangkok

Tel: +662 186 7000-99

TW – Taiwan, Taipei

Tel: +886 2 2298 8987

South America

AR – Argentina, Buenos Aires

Tel: +54 3327 44 4129

BR – Brazil, Sao Jose dos Campos

Tel: +55 800 727 5374

CL – Chile, Santiago

Tel: +56 2 623 1216

MX – Mexico, Apodaca

Tel: +52 81 8156 6000

European Product Information Centre

Free phone: 00 800 27 27 5374

(from AT, BE, CH, CZ, DE, DK, EE, ES, FI,
FR, IE, IL, IS, IT, LU, MT, NL, NO, PL, PT, RU,
SE, SK, UK, ZA)

Parker Hannifin Ltd.

Tachbrook Park Drive

Tachbrook Park,

Warwick, CV34 6TU

United Kingdom

Tel.: +44 (0) 1926 317 878

Fax: +44 (0) 1926 317 855

parker.uk@parker.com

www.parker.com

